

FEATURES

- ▶ 2"x 1"x 0.4" Metal Package
- ▶ Wide 2:1 Input Range
- ▶ High Efficiency up to 86%
- ▶ Operating Ambient Temp. Range -40°C to +80°C
- ▶ Short Circuit Protection
- ▶ I/O-isolation 1500 VDC
- ▶ Input Filter meets EN 55022, class A and FCC, level A (Option)
- ▶ Heatsink (Option)
- ▶ Cost optimized Design

PRODUCT OVERVIEW

The MINMAX MKW2500 series is a range of isolated 15W DC/DC converter modules featuring fully regulated output voltages and wide 2:1 input voltage ranges. The product comes in a 2"x 1"x 0.4" metal package with industry standard pinout. An excellent efficiency allows an operating temperature range of -40°C to +80°C. They feature as option input filter to meet EN55022, class A and remote On/Off input.

These DC/DC converters offer an economical solution for many cost critical applications in battery-powered equipment and instrumentation.

Model Selection Guide

Model Number	Input Voltage (Range) VDC	Output Voltage VDC	Output Current		Input Current		Reflected Ripple Current mA(typ.)	Max. capacitive Load μF	Efficiency (typ.) @Max. Load %	
			Max. mA	Min. mA	@Max. Load mA(typ.)	@No Load mA(typ.)				
MKW2521	12 (9 ~ 18)	3.3	3000	300	1057	30	50	470	78	
MKW2522		5	3000	300	1524				82	
MKW2529		5.1	3000	300	1574				81	
MKW2523		12	1250	125	1452				86	
MKW2524		15	1000	100	1452				86	
MKW2526		±12	±625	±62.5	1452				220#	86
MKW2527		±15	±500	±50	1452					86
MKW2531		24 (18 ~ 36)	3.3	3000	300				528	20
MKW2532	5		3000	300	762	82				
MKW2539	5.1		3000	300	787	81				
MKW2533	12		1250	125	726	86				
MKW2534	15		1000	100	726	86				
MKW2536	±12		±625	±62.5	726	220#	86			
MKW2537	±15		±500	±50	726		86			
MKW2541	48 (36 ~ 75)		3.3	3000	300	264	10	30	470	
MKW2542		5	3000	300	381	82				
MKW2549		5.1	3000	300	393	81				
MKW2543		12	1250	125	363	86				
MKW2544		15	1000	100	363	86				
MKW2546		±12	±625	±62.5	363	220#				86
MKW2547		±15	±500	±50	363					86

For each output

Input Specifications

Parameter	Model	Min.	Typ.	Max.	Unit
Input Surge Voltage (1 sec. max.)	12V Input Models	-0.7	---	25	VDC
	24V Input Models	-0.7	---	50	
	48V Input Models	-0.7	---	100	
Start-Up Voltage	12V Input Models	8	8.5	9	
	24V Input Models	15	17	18	
	48V Input Models	30	33	36	
Under Voltage Shutdown	12V Input Models	7	8	8.5	
	24V Input Models	13	15	17	
	48V Input Models	25	29	34	
Short Circuit Input Power		---	---	3500	mW
Input Filter	All Models	Internal Pi Type			
Conducted EMI (with suffix A only)		Compliance to EN 55022,class A and FCC part 15,class A			

Remote On/Off Control

Parameter	Conditions	Min.	Typ.	Max.	Unit
Converter On	2.5V ~ 5.5V or Open Circuit				
Converter Off	-0.7V ~ 0.8V or Short Circuit				
Control Input Current (on)	Vctrl = 5.0V	---	---	50	μA
Control Input Current (off)	Vctrl = 0V	---	---	-1	mA
Control Common	Referenced to Negative Input				
Standby Input Current	Nominal Vin	---	---	10	mA

Output Specifications

Parameter	Conditions	Min.	Typ.	Max.	Unit
Output Voltage Setting Accuracy		---	±1.0	±2.0	%Vnom.
Output Voltage Balance	Dual Output, Balanced Loads	---	±0.5	±2.0	%
Line Regulation	Vin=Min. to Max. @Full Load	---	±0.1	±0.5	%
Load Regulation	Io=10% to 100%	---	±0.5	±1.0	%
Ripple & Noise	0-20 MHz Bandwidth	---	55	80	mV _{p-p}
Transient Recovery Time	25% Load Step Change	---	300	500	μsec
Transient Response Deviation		---	±2	±4	%
Temperature Coefficient		---	±0.01	±0.02	%/°C
Over Current Protection	Foldback	120	150	---	%
Short Circuit Protection	Continuous, Automatic Recovery				

General Specifications

Parameter	Conditions	Min.	Typ.	Max.	Unit
I/O Isolation Voltage	60 Seconds	1500	---	---	VDC
	1 Second	1800	---	---	VDC
I/O Isolation Resistance	500 VDC	1000	---	---	MΩ
I/O Isolation Capacitance	100KHz, 1V	---	1200	1500	pF
Switching Frequency		290	330	400	KHz
MTBF (calculated)	MIL-HDBK-217F@25°C, Ground Benign	700,000			Hours
Safety Approvals	UL/cUL 60950-1 recognition (CSA certificate), IEC/EN 60950-1(CB-report)				

Environmental Specifications

Parameter	Conditions	Min.	Max.	Unit
Operating Ambient Temperature Range (See Power Derating Curve)	Natural Convection	-40	+80	°C
Case Temperature		---	+100	°C
Storage Temperature Range		-50	+125	°C
Humidity (non condensing)		---	95	% rel. H
Cooling	Natural Convection			
Lead Temperature (1.5mm from case for 10Sec.)		---	260	°C

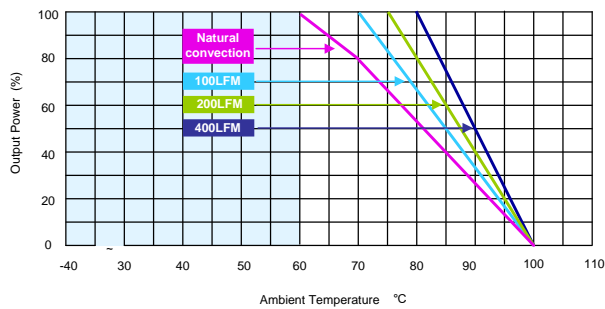
Power Derating Curve

Derating Curve without Heatsink

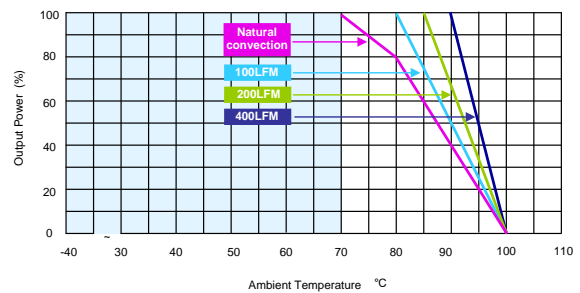

Derating Curve with Heatsink

Notes

- 1 Specifications typical at $T_a=+25^{\circ}\text{C}$, resistive load, nominal input voltage and rated output current unless otherwise noted.
- 2 Transient recovery time is measured to within 1% error band for a step change in output load of 75% to 100%
- 3 These power converters require a minimum output loading to maintain specified regulation, operation under no-load conditions will not damage these modules; however they may not meet all specifications listed.
- 4 We recommend to protect the converter by a slow blow fuse in the input supply line.
- 5 Other input and output voltage may be available, please contact factory.
- 6 That "natural convection" is about 20LFM but is not equal to still air (0 LFM).
- 7 Specifications are subject to change without notice.

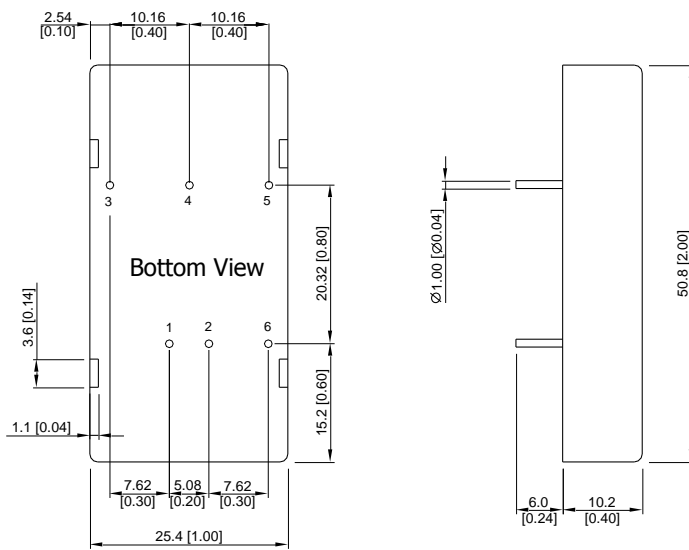
Package Specifications
Mechanical Dimensions

Pin Connections

Pin	Single Output	Dual Output
1	+Vin	+Vin
2	-Vin	-Vin
3	+Vout	+Vout
4	No Pin	Common
5	-Vout	-Vout
6	Remote On/Off (Optional)	

NC: No Connection

- ▶ All dimensions in mm (inches)
- ▶ Tolerance: X.X \pm 0.25 (X.XX \pm 0.01)
X.XX \pm 0.13 (X.XXX \pm 0.005)
- ▶ Pin diameter $\varnothing 1.0 \pm 0.05$ (0.04 ± 0.002)

Physical Characteristics

Case Size	: 50.8x25.4x10.2mm (2.0x1.0x0.40 inches)
Case Material	: Metal With Non-Conductive Baseplate
Base Material	: FR4 PCB (flammability to UL 94V-0 rated)
Pin Material	: Copper Alloy with Gold Plate Over Nickel Subplate
Weight	: 32g

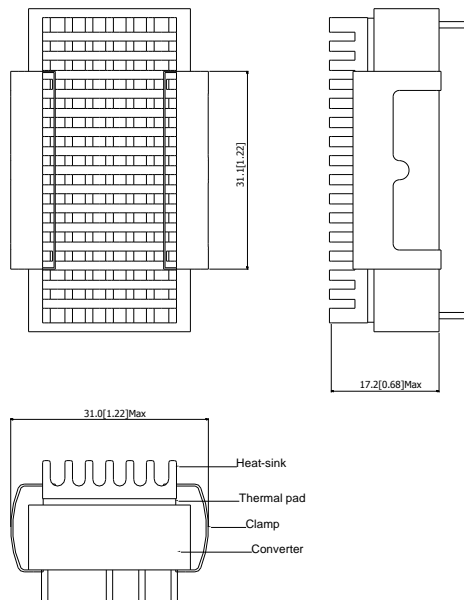
Heatsink (Option -H)

Physical Characteristics

Heatsink Material	: Aluminum
Finish	: Black Anodized Coating
Weight	: 9g

- ▶ The advantages of adding a heatsink are:
 1. To improve heat dissipation and increase the stability and reliability of the DC/DC converters at high operating temperatures.
 2. To increase operating temperature of the DC/DC converter, please refer to Derating Curve.

Order Code Table							
Standard	With EMI	With heatsink	With Remote On/Off	With EMI & heatsink	With EMI & Remote On/Off	With heatsink & Remote On/Off	With EMI, heatsink & Remote On/Off
MKW2521	MKW2521A	MKW2521H	MKW2521-RC	MKW2521AH	MKW2521A-RC	MKW2521H-RC	MKW2521AH-RC
MKW2522	MKW2522A	MKW2522H	MKW2522-RC	MKW2522AH	MKW2522A-RC	MKW2522H-RC	MKW2522AH-RC
MKW2529	MKW2529A	MKW2529H	MKW2529-RC	MKW2529AH	MKW2529A-RC	MKW2529H-RC	MKW2529AH-RC
MKW2523	MKW2523A	MKW2523H	MKW2523-RC	MKW2523AH	MKW2523A-RC	MKW2523H-RC	MKW2523AH-RC
MKW2524	MKW2524A	MKW2524H	MKW2524-RC	MKW2524AH	MKW2524A-RC	MKW2524H-RC	MKW2524AH-RC
MKW2526	MKW2526A	MKW2526H	MKW2526-RC	MKW2526AH	MKW2526A-RC	MKW2526H-RC	MKW2526AH-RC
MKW2527	MKW2527A	MKW2527H	MKW2527-RC	MKW2527AH	MKW2527A-RC	MKW2527H-RC	MKW2527AH-RC
MKW2531	MKW2531A	MKW2531H	MKW2531-RC	MKW2531AH	MKW2531A-RC	MKW2531H-RC	MKW2531AH-RC
MKW2532	MKW2532A	MKW2532H	MKW2532-RC	MKW2532AH	MKW2532A-RC	MKW2532H-RC	MKW2532AH-RC
MKW2539	MKW2539A	MKW2539H	MKW2539-RC	MKW2539AH	MKW2539A-RC	MKW2539H-RC	MKW2539AH-RC
MKW2533	MKW2533A	MKW2533H	MKW2533-RC	MKW2533AH	MKW2533A-RC	MKW2533H-RC	MKW2533AH-RC
MKW2534	MKW2534A	MKW2534H	MKW2534-RC	MKW2534AH	MKW2534A-RC	MKW2534H-RC	MKW2534AH-RC
MKW2536	MKW2536A	MKW2536H	MKW2536-RC	MKW2536AH	MKW2536A-RC	MKW2536H-RC	MKW2536AH-RC
MKW2537	MKW2537A	MKW2537H	MKW2537-RC	MKW2537AH	MKW2537A-RC	MKW2537H-RC	MKW2537AH-RC
MKW2541	MKW2541A	MKW2541H	MKW2541-RC	MKW2541AH	MKW2541A-RC	MKW2541H-RC	MKW2541AH-RC
MKW2542	MKW2542A	MKW2542H	MKW2542-RC	MKW2542AH	MKW2542A-RC	MKW2542H-RC	MKW2542AH-RC
MKW2549	MKW2549A	MKW2549H	MKW2549-RC	MKW2549AH	MKW2549A-RC	MKW2549H-RC	MKW2549AH-RC
MKW2543	MKW2543A	MKW2543H	MKW2543-RC	MKW2543AH	MKW2543A-RC	MKW2543H-RC	MKW2543AH-RC
MKW2544	MKW2544A	MKW2544H	MKW2544-RC	MKW2544AH	MKW2544A-RC	MKW2544H-RC	MKW2544AH-RC
MKW2546	MKW2546A	MKW2546H	MKW2546-RC	MKW2546AH	MKW2546A-RC	MKW2546H-RC	MKW2546AH-RC
MKW2547	MKW2547A	MKW2547H	MKW2547-RC	MKW2547AH	MKW2547A-RC	MKW2547H-RC	MKW2547AH-RC

Test Setup

Input Reflected-Ripple Current Test Setup

Input reflected-ripple current is measured with an inductor L_{in} (4.7 μ H) and C_{in} (220 μ F, ESR < 1.0 Ω at 100 KHz) to simulate source impedance. Capacitor C_{in} , offsets possible battery impedance. Current ripple is measured at the input terminals of the module, measurement bandwidth is 0-500 KHz.

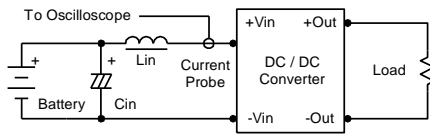

Peak-to-Peak Output Noise Measurement Test

Use a C_{out} 0.47 μ F ceramic capacitor. Scope measurement should be made by using a BNC socket, measurement bandwidth is 0-20 MHz. Position the load between 50 mm and 75 mm from the DC/DC Converter.

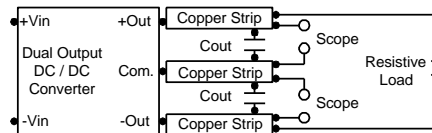
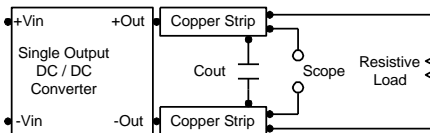

Technical Notes

Remote On/Off

Positive logic remote on/off turns the module on during a logic high voltage on the remote on/off pin, and off during a logic low. To turn the power module on and off, the user must supply a switch to control the voltage between the on/off terminal and the -Vin terminal. The switch can be an open collector or equivalent.

A logic low is -0.7V to 0.8V. A logic high is 2.5V to 5.5V. The maximum sink current at on/off terminal during a logic low is -1 mA. The maximum allowable leakage current of the switch at on/off terminal (2.5 to 5.5V) is 50 μ A.

Overcurrent Protection

To provide protection in a fault (output overload) condition, the unit is equipped with internal current limiting circuitry and can endure current limiting for an unlimited duration. At the point of current-limit inception, the unit shifts from voltage control to current control. The unit operates normally once the output current is brought back into its specified range.

Input Source Impedance

The power module should be connected to a low ac-impedance input source. Highly inductive source impedances can affect the stability of the power module.

In applications where power is supplied over long lines and output loading is high, it may be necessary to use a capacitor at the input to ensure startup.

Capacitor mounted close to the power module helps ensure stability of the unit, it is recommended to use a good quality low Equivalent Series Resistance (ESR < 1.0 Ω at 100 KHz) capacitor of a 22 μ F for the 12V input devices and a 6.8 μ F for the 24V and 48V devices.

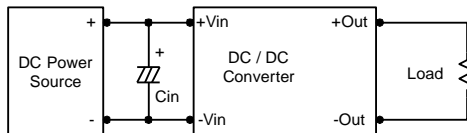

Output Ripple Reduction

A good quality low ESR capacitor placed as close as practicable across the load will give the best ripple and noise performance. To reduce output ripple, it is recommended to use 4.7 μ F capacitors at the output.

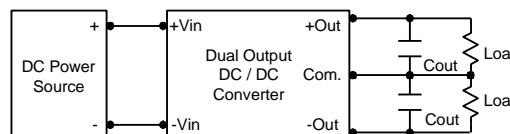
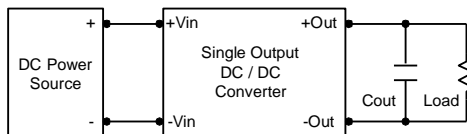

Maximum Capacitive Load

The MKW2500 series has limitation of maximum connected capacitance at the output. The power module may be operated in current limiting mode during start-up, affecting the ramp-up and the startup time. For optimum performance we recommend 220 μ F maximum capacitive load for dual outputs and 470 μ F capacitive load for single outputs. The maximum capacitance can be found in the data sheet.

Thermal Considerations

Many conditions affect the thermal performance of the power module, such as orientation, airflow over the module and board spacing. To avoid exceeding the maximum temperature rating of the components inside the power module, the case temperature must be kept below 100 $^{\circ}$ C.

The derating curves are determined from measurements obtained in a test setup.

