



## MCW03 Series

DC-DC CONVERTER 3W, SIP Package

### Features

- ▶ Compact SIP-8 Package
- ▶ Wide 2 : 1 Input Voltage Range
- ▶ Fully Regulated Output Voltage
- ▶ I/O Isolation 1600 VDC
- ▶ Operating Ambient Temp. Range -40°C to +85°C
- ▶ Overload and Short Circuit Protection
- ▶ Remote On/Off Control
- ▶ UL/cUL/IEC/EN 62368-1(60950-1) Safety Approval

## Electric Characteristic Note



### Applications

- ▶ Distributed power architectures
- ▶ Workstations
- ▶ Computer equipment
- ▶ Communications equipment

### Product Overview

The MINMAX MCW03 series is a range of isolated 3W DC-DC converter modules featuring fully regulated output and wide 2:1 input voltage ranges.

The product comes in a SIP-8 package with a very small footprint occupying only 2.0 cm<sup>2</sup> (0.3 square in.) on the PCB.

An excellent efficiency allows an operating temperature range of -40°C to +85°C. Further features include remote On/Off control and over load protection.

The very compact dimensions of these DC-DC converters make them an ideal solution for many space critical applications in battery-powered equipment and instrumentation.

### Table of contents

Model Selection Guide.....	P2	Recommended Pad Layout for Single & Dual Output Converter....	P32
Input Specifications.....	P2	Test Setup.....	P33
Remote On/Off Control.....	P3	Technical Notes .....	P33
Output Specifications.....	P3	Remote ON/OFF Implementation.....	P34
General Specifications.....	P3	Packaging Information.....	P34
Environmental Specifications.....	P3	Wave Soldering Considerations.....	P35
Characteristic Curves.....	P4	Part Number Structure.....	P36
Package Specifications.....	P32	MTBF and Reliability.....	P36

Model Selection Guide								
Model Number	Input Voltage (Range)	Output Voltage	Output Current		Input Current		Max. capacitive Load	Efficiency (typ.)
			Max.	Min.	@Max. Load	@No Load		@Max. Load
	VDC	VDC	mA	mA	mA(typ.)	mA(typ.)	μF	%
MCW03-05S033	5 (4.5 ~ 9)	3.3	700	175	651	70	1760	71
MCW03-05S05		5	600	150	822		1000	73
MCW03-05S12		12	250	63	759		170	79
MCW03-05S15		15	200	50	759		110	79
MCW03-05D05		±5	±300	±75	811		470 #	74
MCW03-05D12		±12	±125	±31	759		100 #	79
MCW03-05D15		±15	±100	±25	759		47 #	79
MCW03-12S033	12 (9 ~ 18)	3.3	700	175	257	20	1760	75
MCW03-12S05		5	600	150	321		1000	78
MCW03-12S12		12	250	63	301		170	83
MCW03-12S15		15	200	50	301		110	83
MCW03-12D05		±5	±300	±75	316		470 #	79
MCW03-12D12		±12	±125	±31	301		100 #	83
MCW03-12D15		±15	±100	±25	301		47 #	83
MCW03-24S033	24 (18 ~ 36)	3.3	700	175	128	10	1760	75
MCW03-24S05		5	600	150	160		1000	78
MCW03-24S12		12	250	63	151		170	83
MCW03-24S15		15	200	50	151		110	83
MCW03-24D05		±5	±300	±75	156		470 #	80
MCW03-24D12		±12	±125	±31	151		100 #	83
MCW03-24D15		±15	±100	±25	151		47 #	83
MCW03-48S033	48 (36 ~ 75)	3.3	700	175	64	8	1760	75
MCW03-48S05		5	600	150	80		1000	78
MCW03-48S12		12	250	63	75		170	83
MCW03-48S15		15	200	50	75		110	83
MCW03-48D05		±5	±300	±75	78		470 #	80
MCW03-48D12		±12	±125	±31	75		100 #	83
MCW03-48D15		±15	±100	±25	75		47 #	83

# For each output

Input Specifications						
Parameter	Model	Min.	Typ.	Max.	Unit	
Input Surge Voltage (1 sec. max.)	5V Input Models	-0.7	---	11	VDC	
	12V Input Models	-0.7	---	25		
	24V Input Models	-0.7	---	50		
	48V Input Models	-0.7	---	100		
Start-Up Threshold Voltage	5V Input Models	3	4	4.5		
	12V Input Models	4.5	7	9		
	24V Input Models	8	12	18		
	48V Input Models	16	24	36		
Under Voltage Shutdown	5V Input Models	---	3.5	4		
	12V Input Models	---	6.5	8.5		
	24V Input Models	---	11	17		
	48V Input Models	---	22	34		
Short Circuit Input Power	All Models	---	---	2500	mW	
Input Filter		Internal Capacitor				

Remote On/Off Control						
Parameter	Conditions	Min.	Typ.	Max.	Unit	
Converter On	Under 0.6 VDC or Open Circuit					
Converter Off	2.7 to 15 VDC					
Standby Input Current	Nominal Vin	---	---	3	mA	
Control Input Current ( on )	Vin = 0V	---	---	1	mA	
Control Input Current ( off )	Vin = 5.0V	---	---	1	mA	
Control Common	Referenced to Negative Input					

Output Specifications						
Parameter	Conditions	Min.	Typ.	Max.	Unit	
Output Voltage Setting Accuracy		---	---	±1.0	%Vnom.	
Output Voltage Balance	Dual Output, Balanced Loads	---	±0.5	±2.0	%	
Line Regulation	Vin=Min. to Max. @Full Load	---	±0.3	±0.5	%	
Load Regulation	Io=25% to 100%	---	±0.5	±1.0	%	
Ripple & Noise	0-20 MHz Bandwidth	---	50	75	mV <sub>P-P</sub>	
Transient Recovery Time	25% Load Step Change	---	300	500	µsec	
Transient Response Deviation		---	±3	±5	%	
Temperature Coefficient		---	---	±0.02	%/ <sup>o</sup> C	
Over Load Protection	Foldback	110	140	---	%	
Short Circuit Protection	Continuous, Automatic Recovery					

General Specifications						
Parameter	Conditions	Min.	Typ.	Max.	Unit	
I/O Isolation Voltage	60 Seconds	1600	---	---	VDC	
	1 Second	1920	---	---	VDC	
I/O Isolation Resistance	500 VDC	1000	---	---	MΩ	
I/O Isolation Capacitance	100kHz, 1V	---	60	200	pF	
Switching Frequency		---	300	---	kHz	
MTBF (calculated)	MIL-HDBK-217F@25°C, Ground Benign	1,000,000			Hours	
Safety Approvals	UL/cUL 60950-1 recognition (CSA certificate), IEC/EN 60950-1(CB-report)					
	UL/cUL 62368-1 recognition (UL certificate), IEC/EN 62368-1 (CB-report)					

Environmental Specifications				
Parameter	Min.	Max.	Unit	
Operating Ambient Temperature Range (See Power Derating Curve)	-40	+85	°C	
Case Temperature	---	+105	°C	
Storage Temperature Range	-55	+125	°C	
Humidity (non condensing)	---	95	% rel. H	
Lead Temperature (1.5mm from case for 10Sec.)	---	260	°C	

Notes	
1	Specifications typical at Ta=+25°C, resistive load, nominal input voltage and rated output current unless otherwise noted.
2	Transient recovery time is measured to within 1% error band for a step change in output load of 75% to 100%.
3	These power converters require a minimum output loading to maintain specified regulation, operation under no-load conditions will not damage these modules; however, they may not meet all specifications listed.
4	We recommend to protect the converter by a slow blow fuse in the input supply line.
5	Other input and output voltage may be available, please contact MINMAX.
6	Specifications are subject to change without notice.

Characteristic Curves

All test conditions are at 25°C The figures are identical for MCW03-05S033

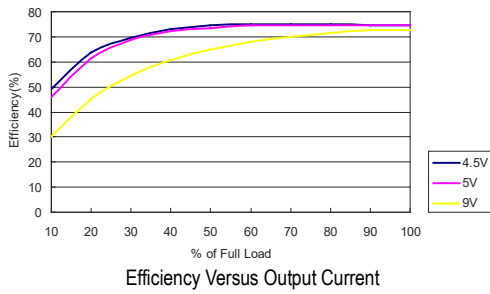

Efficiency Versus Output Current

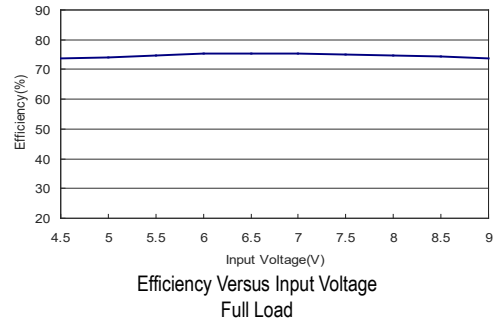

Efficiency Versus Input Voltage Full Load

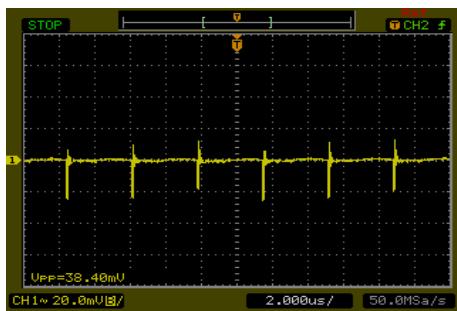

Typical Output Ripple and Noise  
 $V_{in}=V_{in\ nom}$ ; Full Load

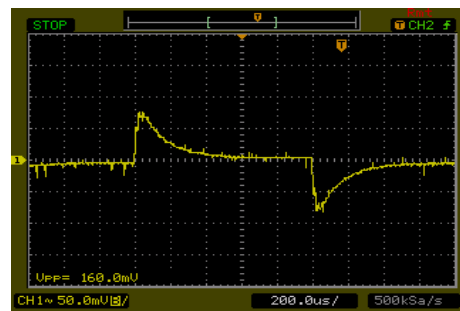

Transient Response to Dynamic Load Change  
from 100% to 75% of Full Load ;  $V_{in}=V_{in\ nom}$

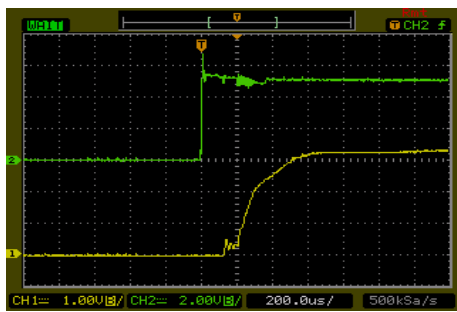

Typical Input Start-Up and Output Rise Characteristic  
 $V_{in}=V_{in\ nom}$ ; Full Load

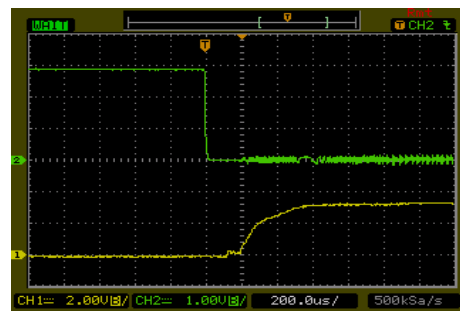

ON/OFF Voltage Start-Up and Output Rise Characteristic  
 $V_{in}=V_{in\ nom}$ ; Full Load

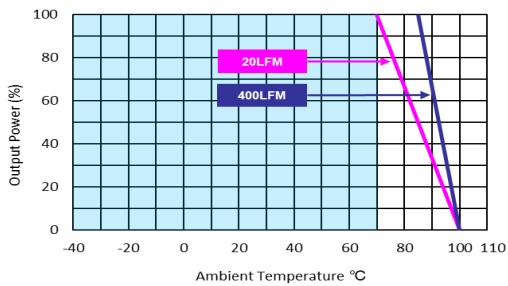

Derating Output Current Versus Ambient Temperature and Airflow  
 $V_{in}=V_{in\ nom}$

**Characteristic Curves**

All test conditions are at 25°C The figures are identical for MCW03-05S05

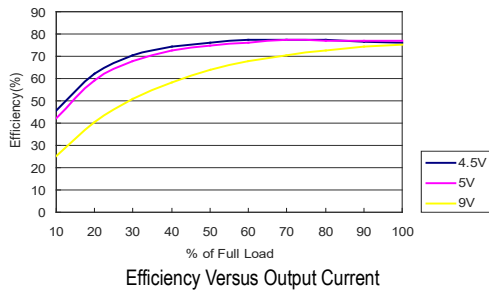

Efficiency Versus Output Current

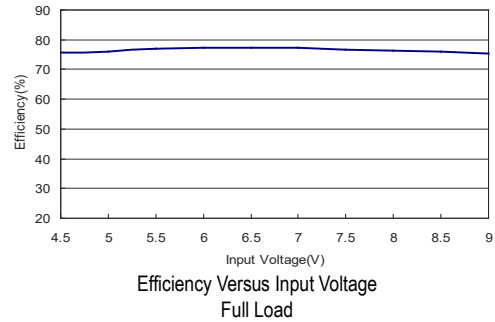

Efficiency Versus Input Voltage Full Load

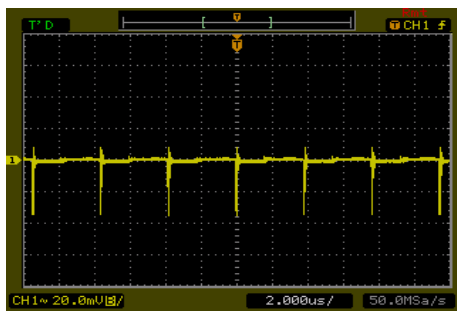

Typical Output Ripple and Noise  
 $V_{in}=V_{in\ nom}$ ; Full Load

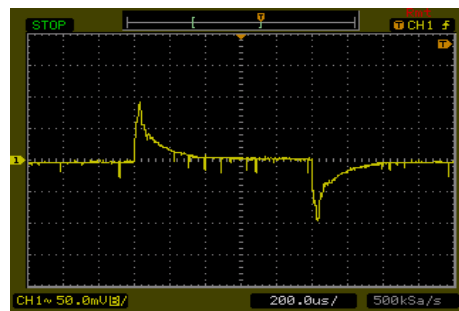

Transient Response to Dynamic Load Change  
from 100% to 75% of Full Load;  $V_{in}=V_{in\ nom}$

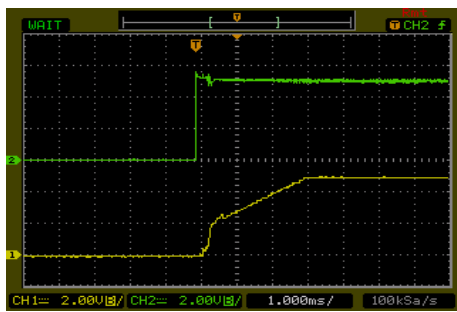

Typical Input Start-Up and Output Rise Characteristic  
 $V_{in}=V_{in\ nom}$ ; Full Load

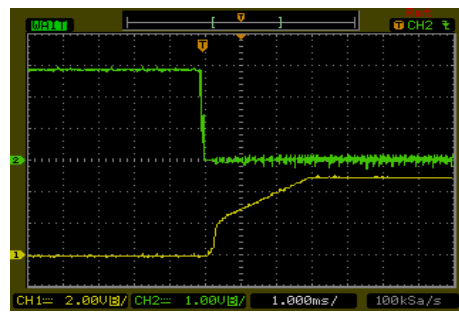

ON/OFF Voltage Start-Up and Output Rise Characteristic  
 $V_{in}=V_{in\ nom}$ ; Full Load

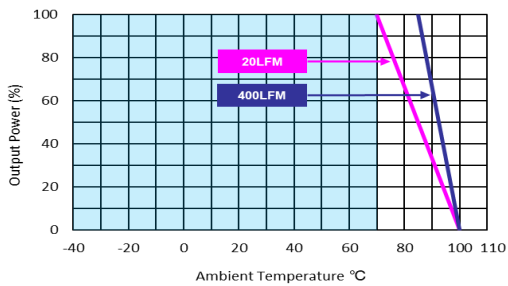

Derating Output Current Versus Ambient Temperature and Airflow  
 $V_{in}=V_{in\ nom}$

Characteristic Curves

All test conditions are at 25°C The figures are identical for MCW03-05S12

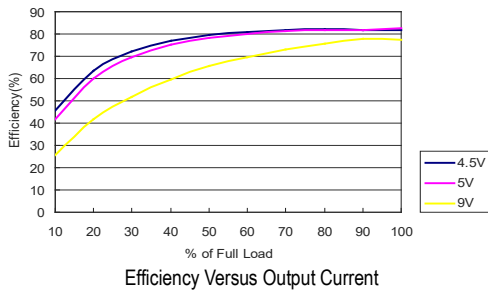

Efficiency Versus Output Current

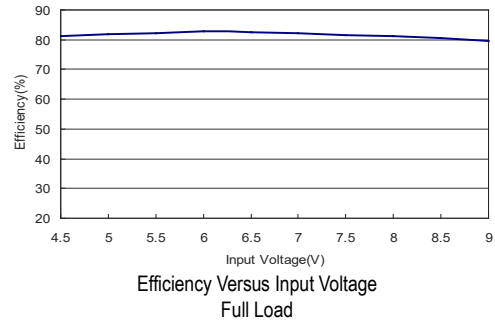

Efficiency Versus Input Voltage Full Load

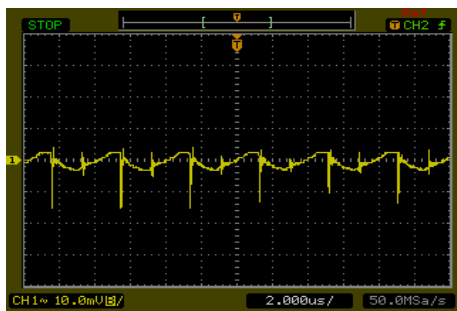

Typical Output Ripple and Noise  
 $V_{in}=V_{in\ nom}$ ; Full Load

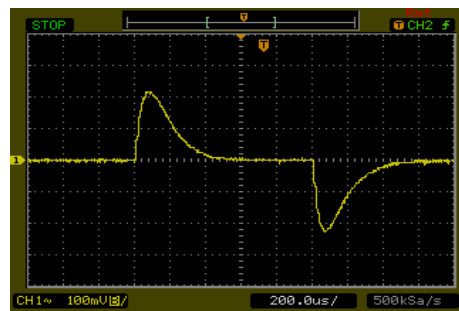

Transient Response to Dynamic Load Change  
 from 100% to 75% of Full Load;  $V_{in}=V_{in\ nom}$

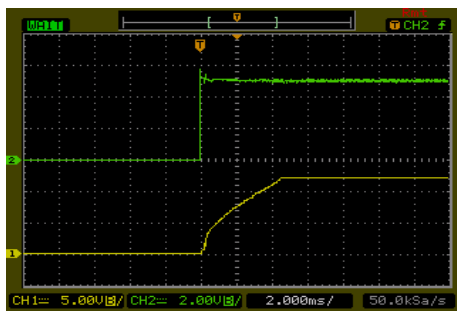

Typical Input Start-Up and Output Rise Characteristic  
 $V_{in}=V_{in\ nom}$ ; Full Load

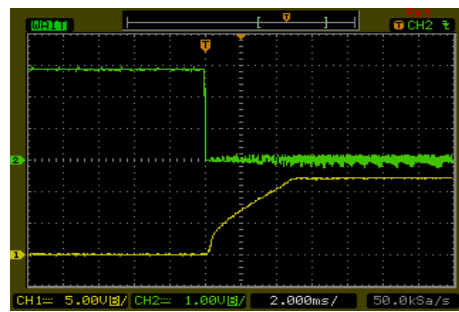

ON/OFF Voltage Start-Up and Output Rise Characteristic  
 $V_{in}=V_{in\ nom}$ ; Full Load

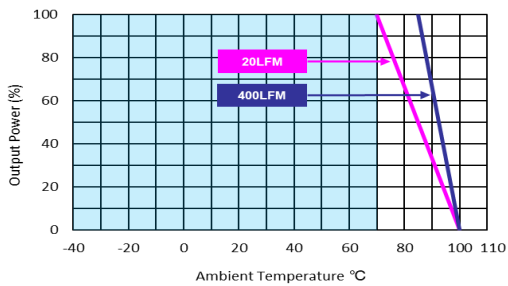

Derating Output Current Versus Ambient Temperature and Airflow  
 $V_{in}=V_{in\ nom}$

Characteristic Curves

All test conditions are at 25°C The figures are identical for MCW03-05S15

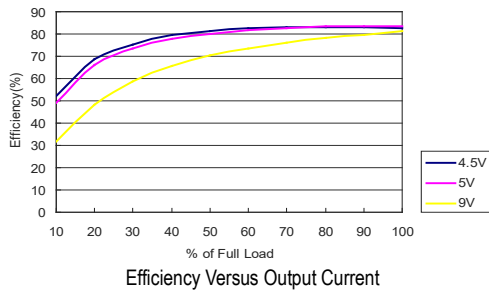

Efficiency Versus Output Current

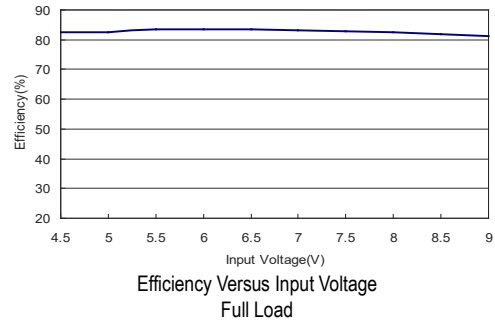

Efficiency Versus Input Voltage Full Load

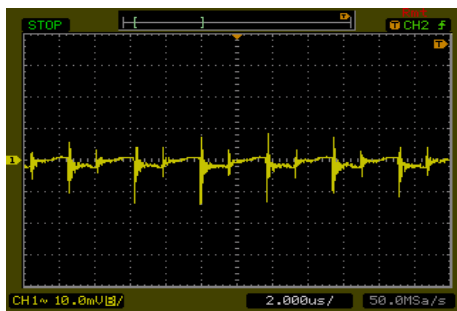

Typical Output Ripple and Noise  
 $V_{in}=V_{in\ nom}$ ; Full Load

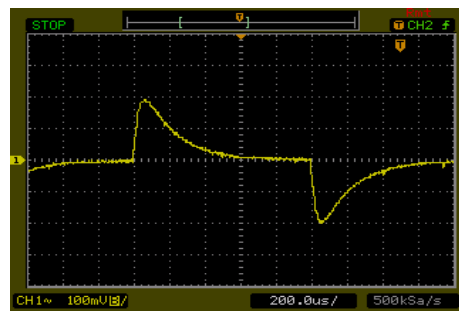

Transient Response to Dynamic Load Change  
 from 100% to 75% of Full Load ;  $V_{in}=V_{in\ nom}$

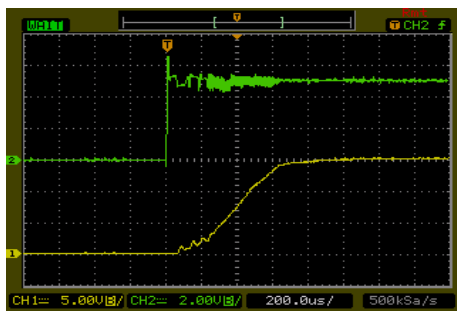

Typical Input Start-Up and Output Rise Characteristic  
 $V_{in}=V_{in\ nom}$ ; Full Load

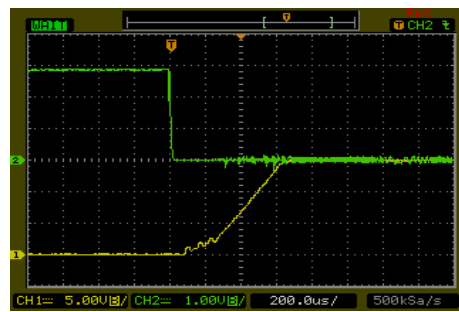

ON/OFF Voltage Start-Up and Output Rise Characteristic  
 $V_{in}=V_{in\ nom}$ ; Full Load

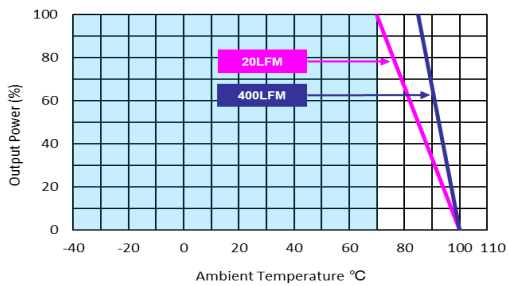

Derating Output Current Versus Ambient Temperature and Airflow  
 $V_{in}=V_{in\ nom}$

Characteristic Curves

All test conditions are at 25°C The figures are identical for MCW03-05D05

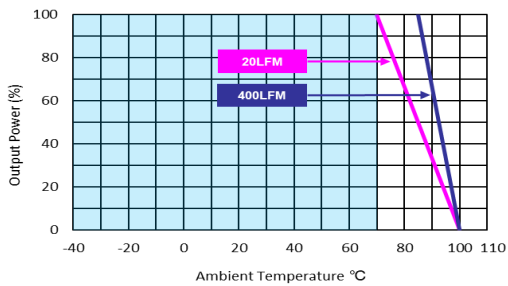
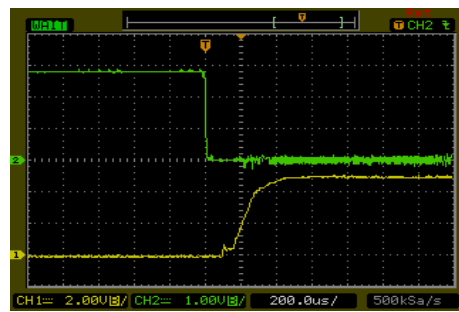
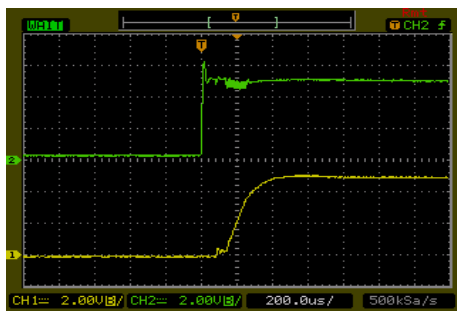
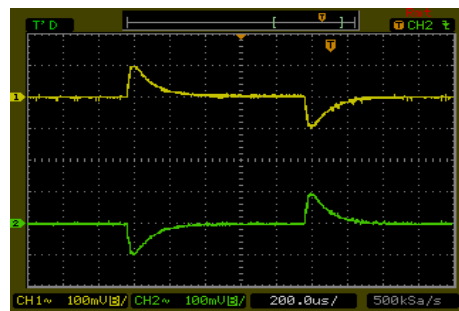
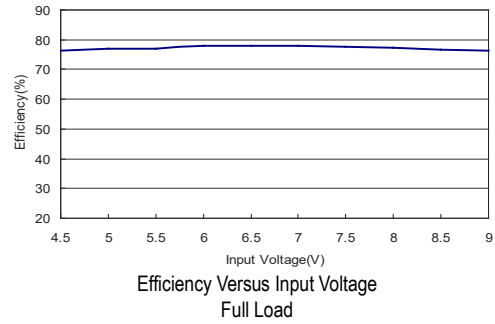
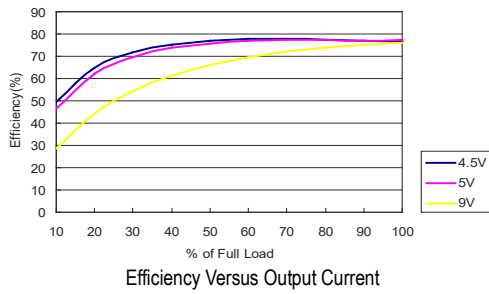



Characteristic Curves

All test conditions are at 25°C The figures are identical for MCW03-05D12

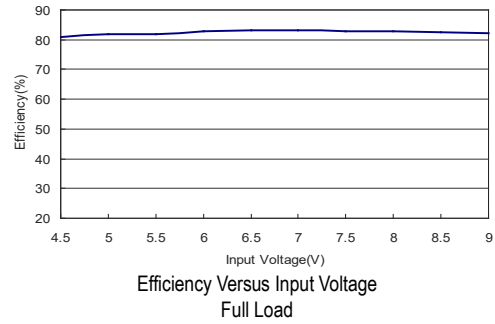
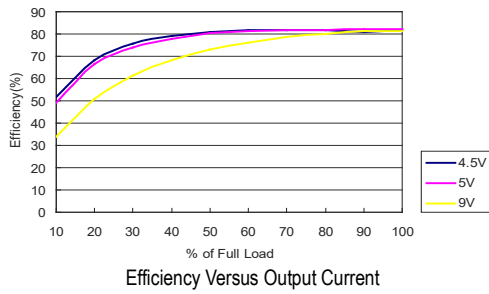

$V_{in}=V_{in\ nom}$ ; Full Load

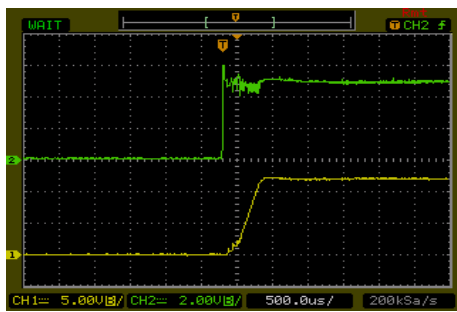
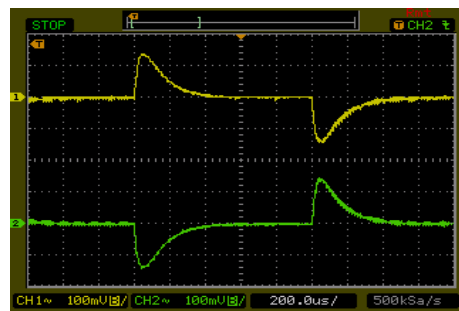

$V_{in}=V_{in\ nom}$ ; Full Load

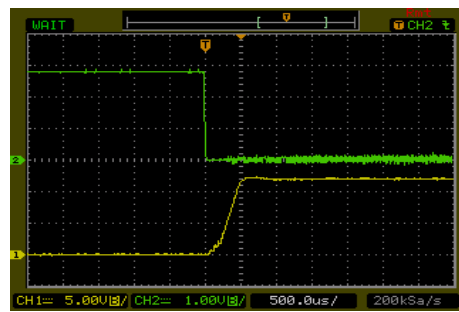

$V_{in}=V_{in\ nom}$ ; Full Load

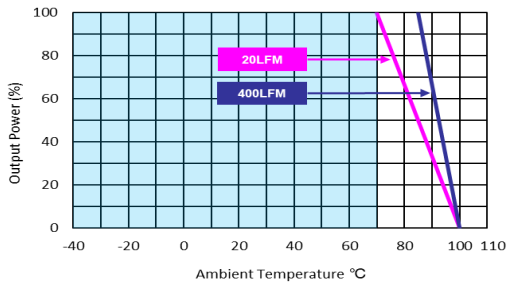

$V_{in}=V_{in\ nom}$

Characteristic Curves

All test conditions are at 25°C The figures are identical for MCW03-05D15

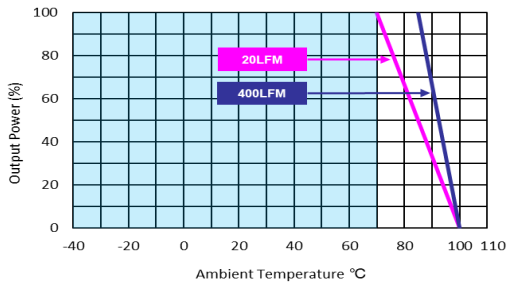
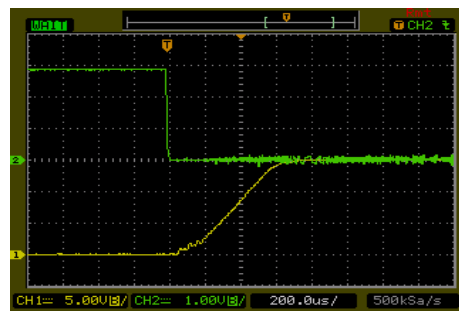
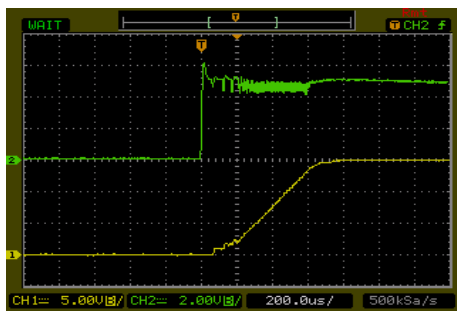
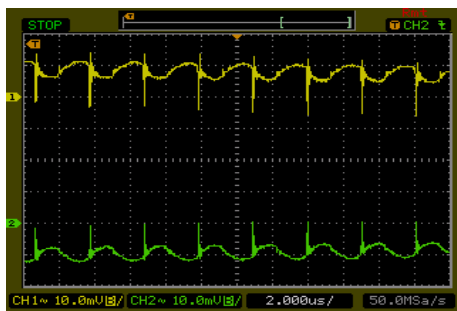
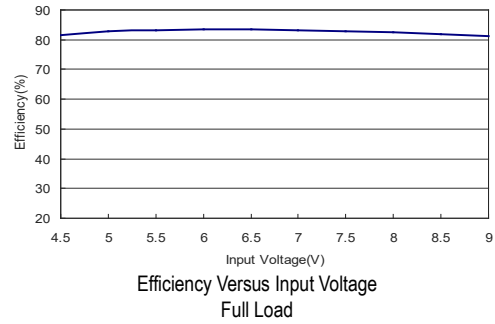
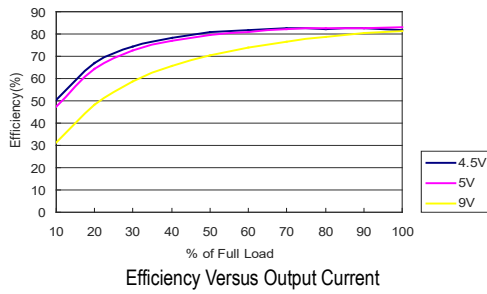

Characteristic Curves

All test conditions are at 25°C The figures are identical for MCW03-12S033

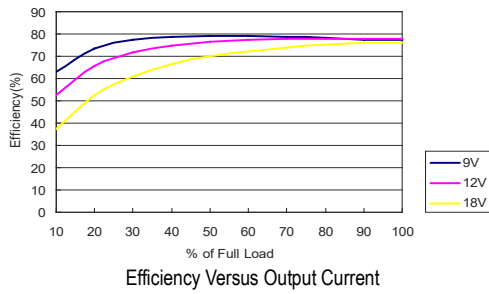

Efficiency Versus Output Current

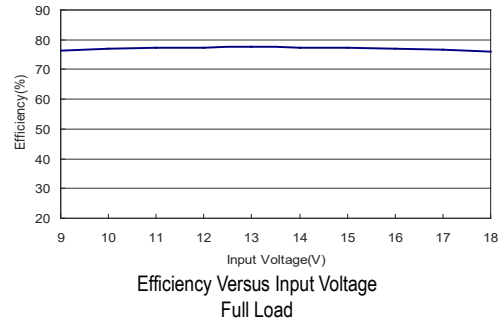

Efficiency Versus Input Voltage Full Load

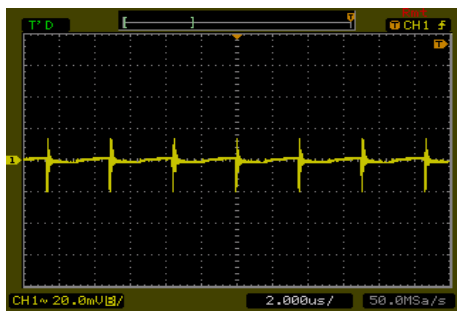

Typical Output Ripple and Noise  
 $V_{in}=V_{in\ nom}$  ; Full Load

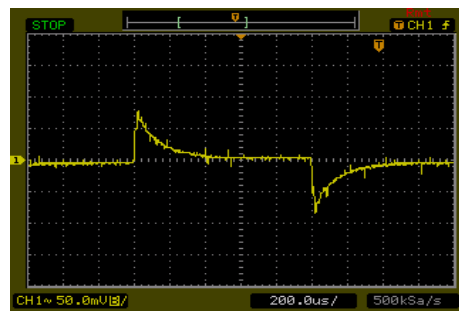

Transient Response to Dynamic Load Change  
 from 100% to 75% of Full Load ;  $V_{in}=V_{in\ nom}$

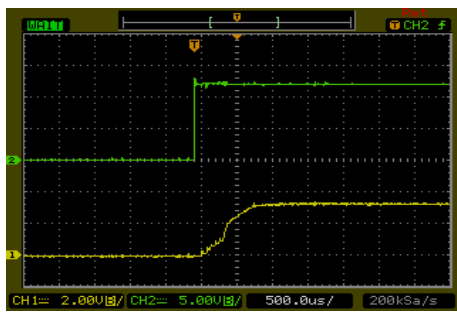

Typical Input Start-Up and Output Rise Characteristic  
 $V_{in}=V_{in\ nom}$  ; Full Load

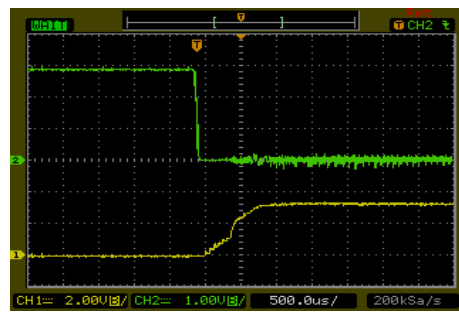

ON/OFF Voltage Start-Up and Output Rise Characteristic  
 $V_{in}=V_{in\ nom}$  ; Full Load

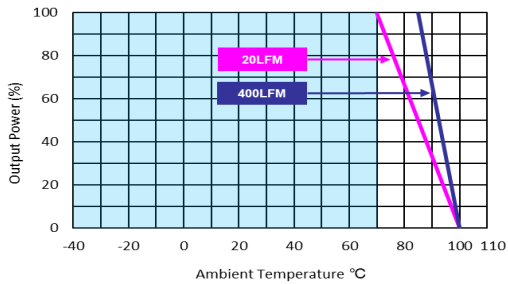

Derating Output Current Versus Ambient Temperature and Airflow  
 $V_{in}=V_{in\ nom}$

Characteristic Curves

All test conditions are at 25°C The figures are identical for MCW03-12S05

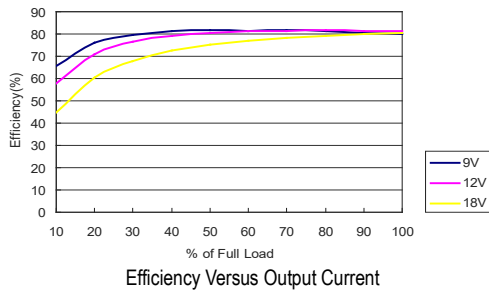

Efficiency Versus Output Current

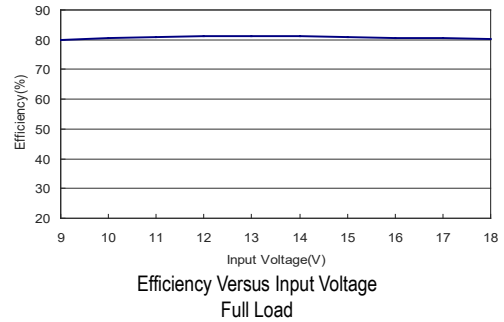

Efficiency Versus Input Voltage Full Load

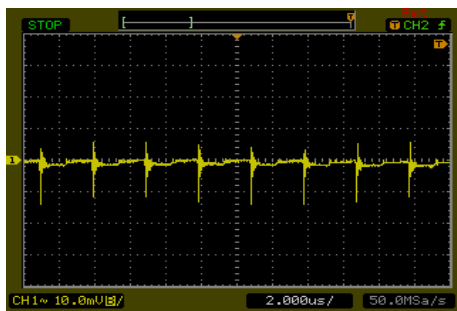

Typical Output Ripple and Noise  
 $V_{in}=V_{in\ nom}$ ; Full Load

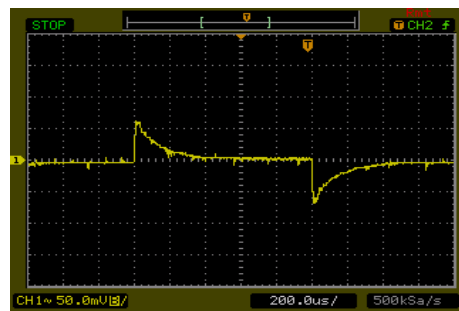

Transient Response to Dynamic Load Change  
from 100% to 75% of Full Load ;  $V_{in}=V_{in\ nom}$

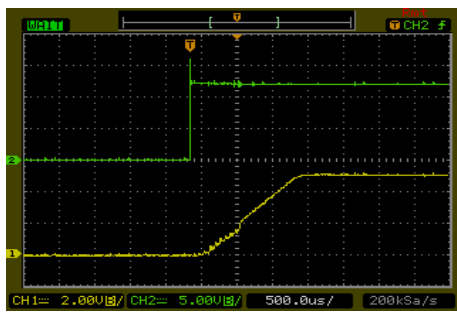

Typical Input Start-Up and Output Rise Characteristic  
 $V_{in}=V_{in\ nom}$ ; Full Load

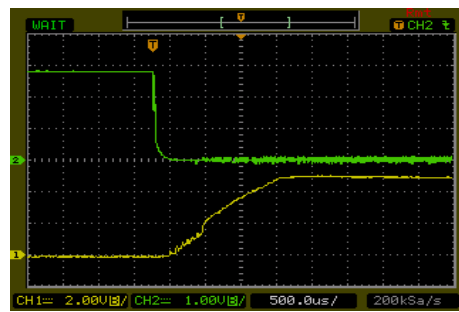

ON/OFF Voltage Start-Up and Output Rise Characteristic  
 $V_{in}=V_{in\ nom}$ ; Full Load

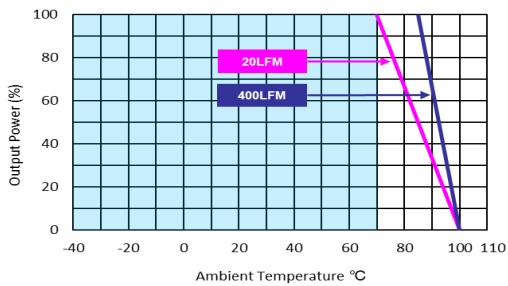

Derating Output Current Versus Ambient Temperature and Airflow  
 $V_{in}=V_{in\ nom}$

Characteristic Curves

All test conditions are at 25°C The figures are identical for MCW03-12S12

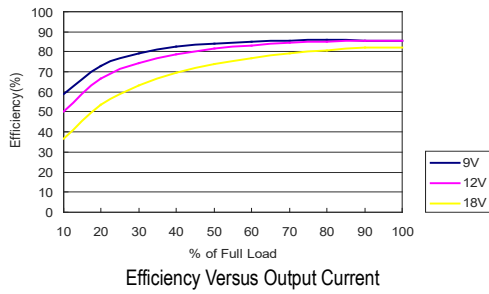

Efficiency Versus Output Current

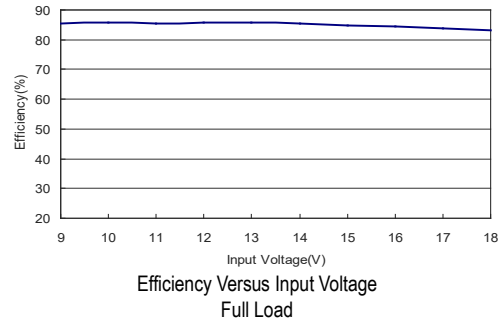

Efficiency Versus Input Voltage Full Load

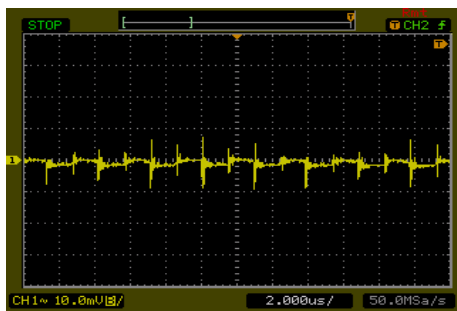

Typical Output Ripple and Noise  
 $V_{in}=V_{in\ nom}$ ; Full Load

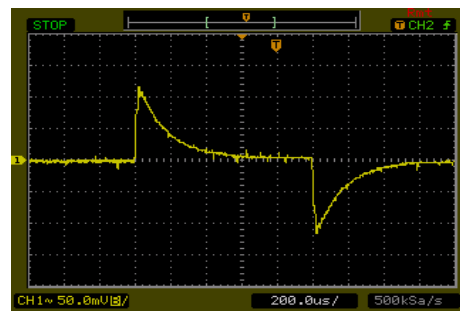

Transient Response to Dynamic Load Change  
from 100% to 75% of Full Load ;  $V_{in}=V_{in\ nom}$

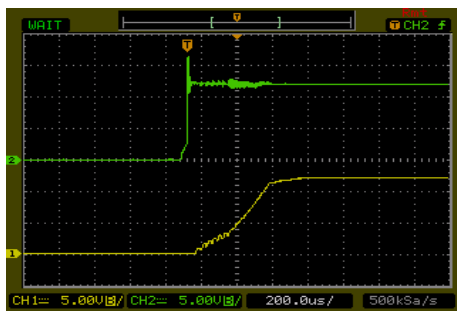

Typical Input Start-Up and Output Rise Characteristic  
 $V_{in}=V_{in\ nom}$ ; Full Load

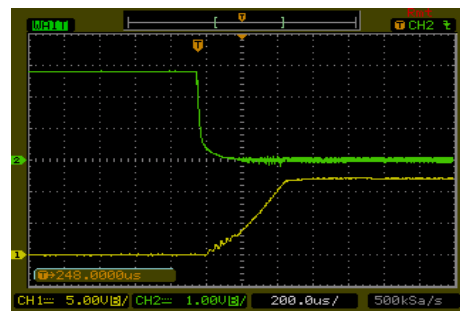

ON/OFF Voltage Start-Up and Output Rise Characteristic  
 $V_{in}=V_{in\ nom}$ ; Full Load

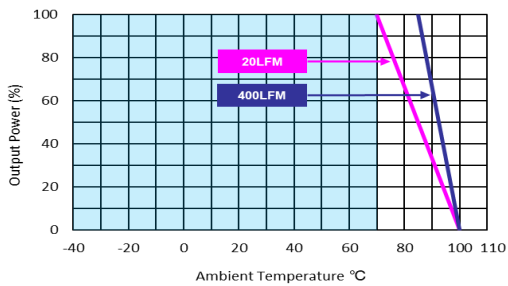

Derating Output Current Versus Ambient Temperature and Airflow  
 $V_{in}=V_{in\ nom}$

Characteristic Curves

All test conditions are at 25°C The figures are identical for MCW03-12S15

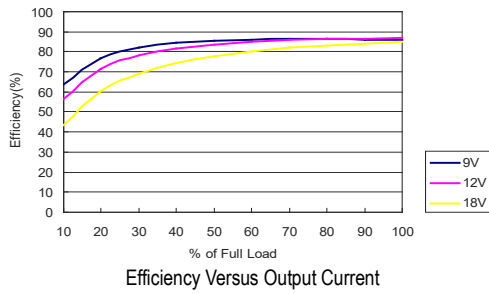

Efficiency Versus Output Current

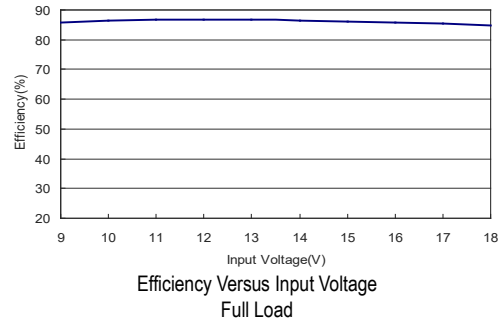

Efficiency Versus Input Voltage Full Load

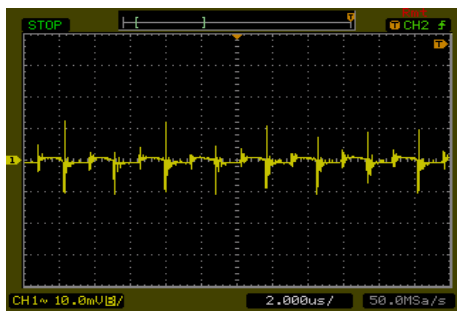

Typical Output Ripple and Noise  
 $V_{in}=V_{in\ nom}$ ; Full Load

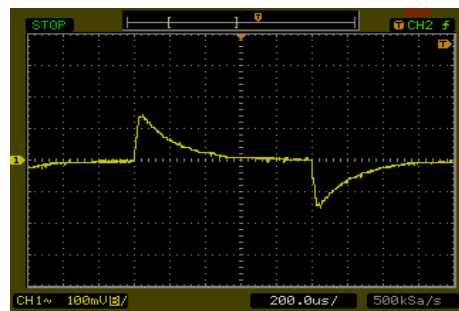

Transient Response to Dynamic Load Change  
from 100% to 75% of Full Load;  $V_{in}=V_{in\ nom}$

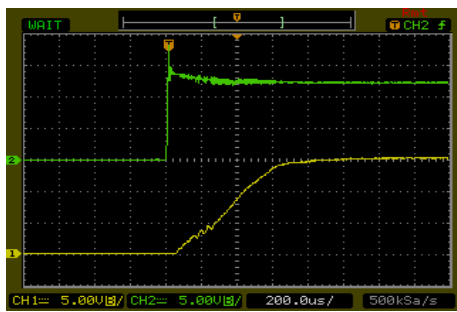

Typical Input Start-Up and Output Rise Characteristic  
 $V_{in}=V_{in\ nom}$ ; Full Load

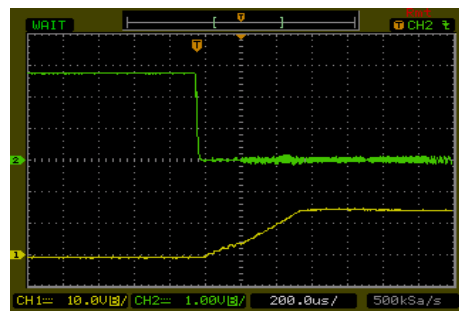

ON/OFF Voltage Start-Up and Output Rise Characteristic  
 $V_{in}=V_{in\ nom}$ ; Full Load

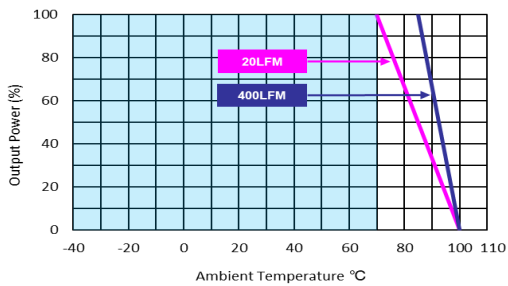

Derating Output Current Versus Ambient Temperature and Airflow  
 $V_{in}=V_{in\ nom}$

Characteristic Curves

All test conditions are at 25°C The figures are identical for MCW03-12D05

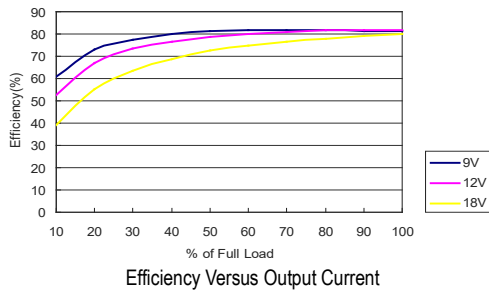

Efficiency Versus Output Current

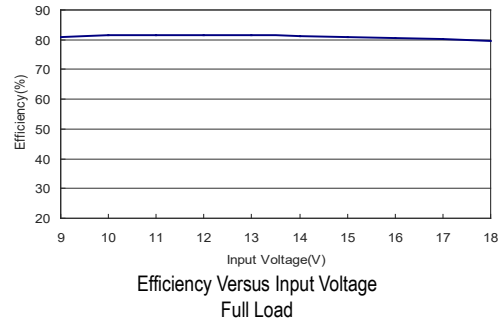

Efficiency Versus Input Voltage Full Load



Typical Output Ripple and Noise  
 $V_{in}=V_{in\ nom}$  ; Full Load

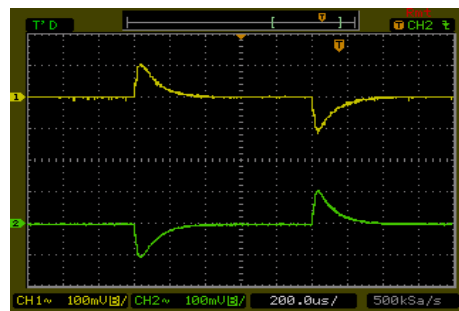

Transient Response to Dynamic Load Change  
 from 100% to 75% of Full Load ;  $V_{in}=V_{in\ nom}$

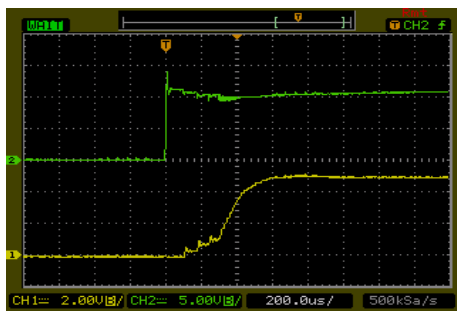

Typical Input Start-Up and Output Rise Characteristic  
 $V_{in}=V_{in\ nom}$  ; Full Load

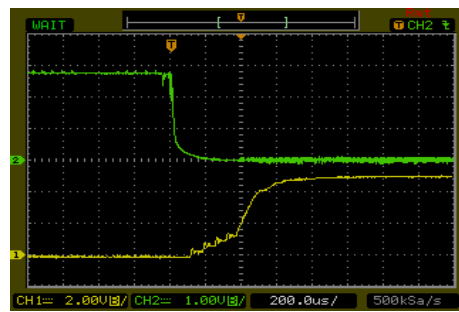

ON/OFF Voltage Start-Up and Output Rise Characteristic  
 $V_{in}=V_{in\ nom}$  ; Full Load

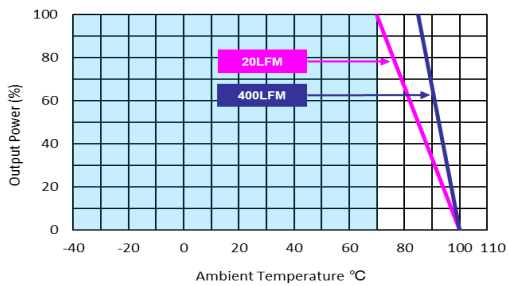

Derating Output Current Versus Ambient Temperature and Airflow  
 $V_{in}=V_{in\ nom}$

Characteristic Curves

All test conditions are at 25°C The figures are identical for MCW03-12D12

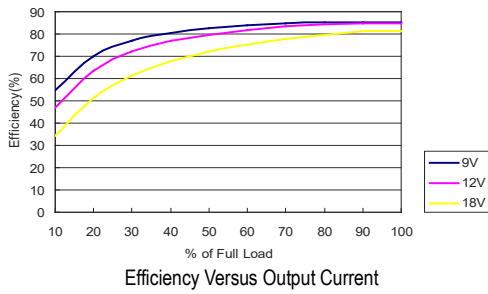

Efficiency Versus Output Current

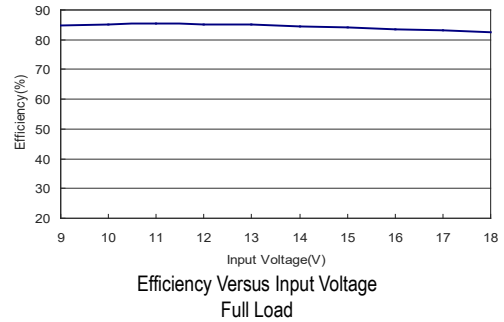

Efficiency Versus Input Voltage Full Load



Typical Output Ripple and Noise  
 $V_{in}=V_{in\ nom}$ ; Full Load



Transient Response to Dynamic Load Change  
from 100% to 75% of Full Load ;  $V_{in}=V_{in\ nom}$

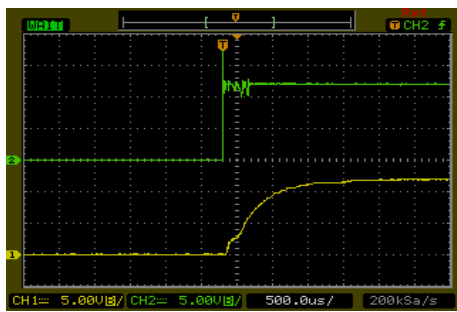

Typical Input Start-Up and Output Rise Characteristic  
 $V_{in}=V_{in\ nom}$ ; Full Load

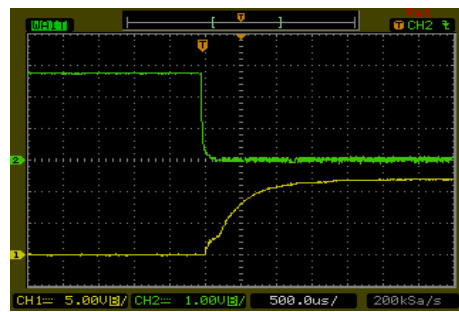

ON/OFF Voltage Start-Up and Output Rise Characteristic  
 $V_{in}=V_{in\ nom}$ ; Full Load

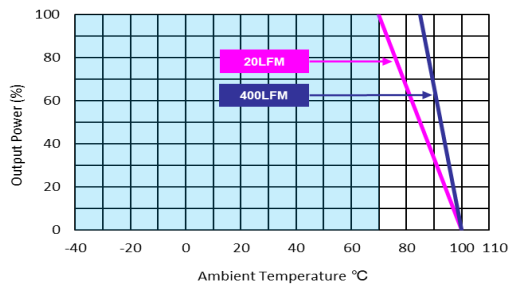

Derating Output Current Versus Ambient Temperature and Airflow  
 $V_{in}=V_{in\ nom}$



Characteristic Curves

All test conditions are at 25°C The figures are identical for MCW03-12D15

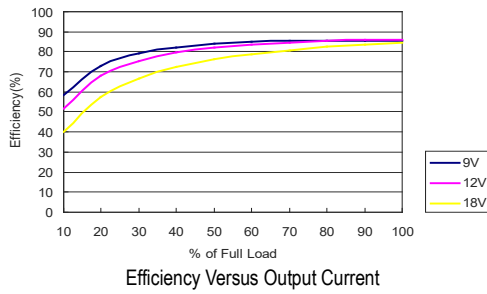

Efficiency Versus Output Current

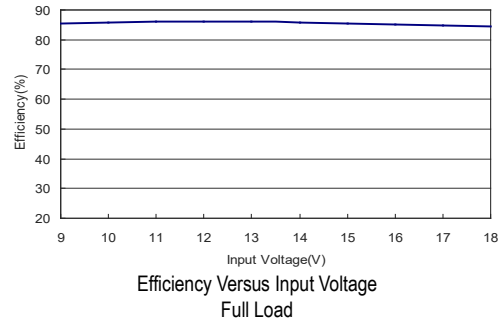

Efficiency Versus Input Voltage Full Load

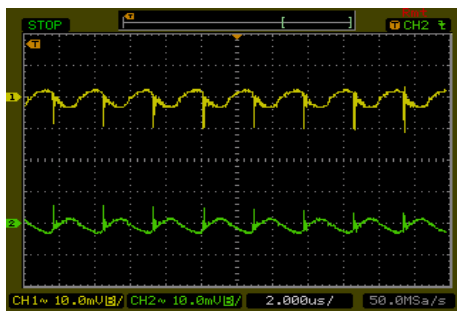

Typical Output Ripple and Noise  
 $V_{in}=V_{in\ nom}$ ; Full Load

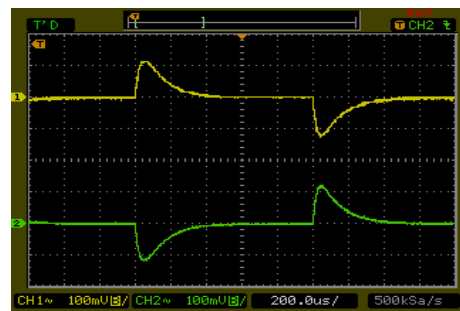

Transient Response to Dynamic Load Change  
from 100% to 75% of Full Load ;  $V_{in}=V_{in\ nom}$

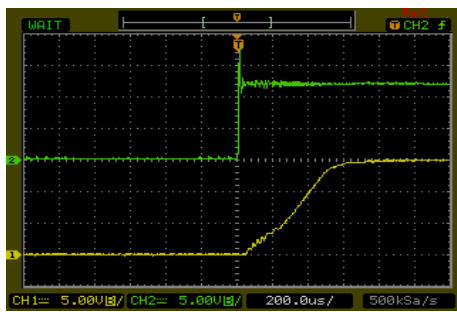

Typical Input Start-Up and Output Rise Characteristic  
 $V_{in}=V_{in\ nom}$ ; Full Load

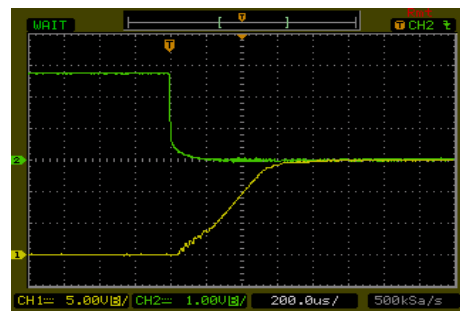

ON/OFF Voltage Start-Up and Output Rise Characteristic  
 $V_{in}=V_{in\ nom}$ ; Full Load

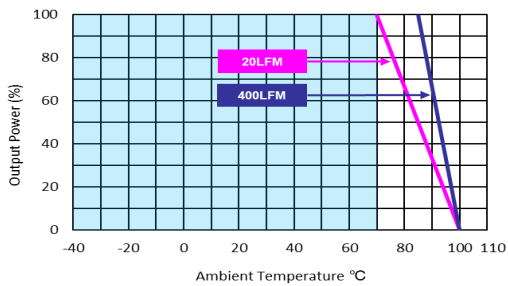

Derating Output Current Versus Ambient Temperature and Airflow  
 $V_{in}=V_{in\ nom}$

Characteristic Curves

All test conditions are at 25°C The figures are identical for MCW03-24S033

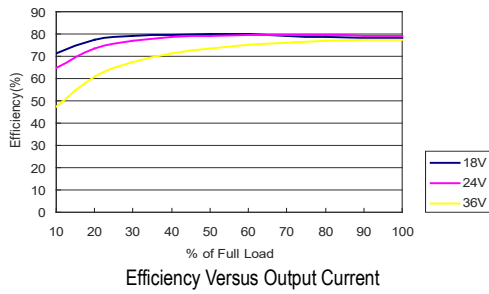

Efficiency Versus Output Current

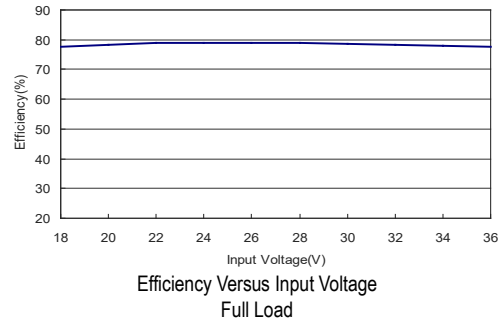

Efficiency Versus Input Voltage Full Load

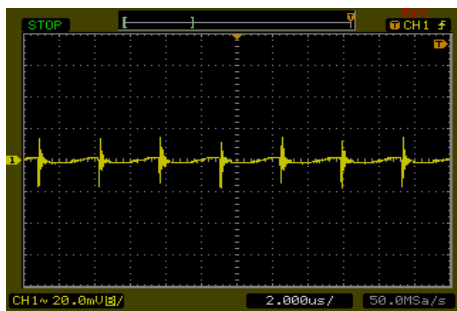

Typical Output Ripple and Noise  
 $V_{in}=V_{in\ nom}$ ; Full Load

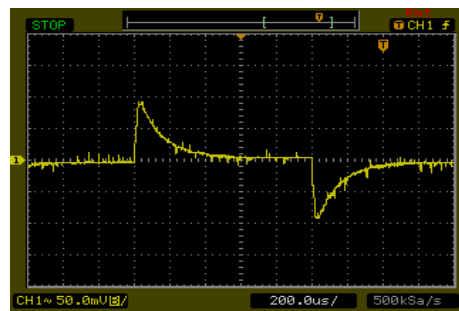

Transient Response to Dynamic Load Change  
 from 100% to 75% of Full Load ;  $V_{in}=V_{in\ nom}$

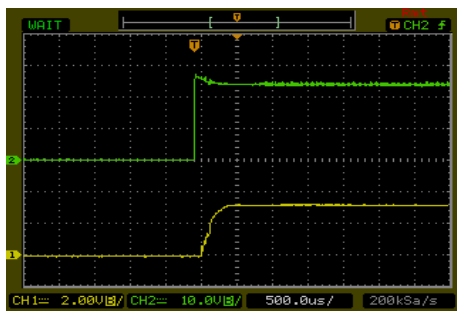

Typical Input Start-Up and Output Rise Characteristic  
 $V_{in}=V_{in\ nom}$ ; Full Load

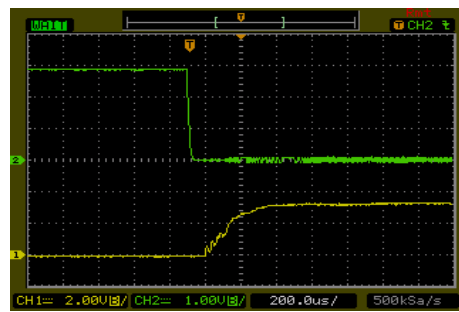

ON/OFF Voltage Start-Up and Output Rise Characteristic  
 $V_{in}=V_{in\ nom}$ ; Full Load

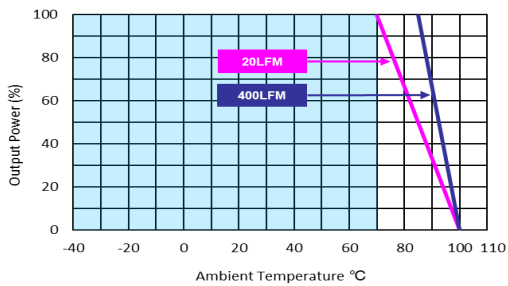

Derating Output Current Versus Ambient Temperature and Airflow  
 $V_{in}=V_{in\ nom}$

Characteristic Curves

All test conditions are at 25°C The figures are identical for MCW03-24S05

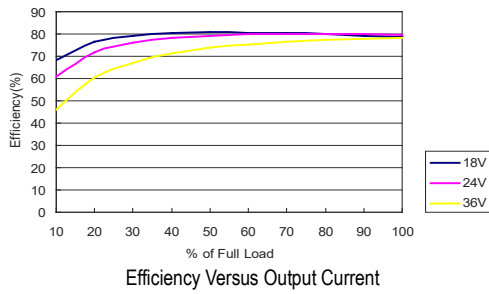

Efficiency Versus Output Current

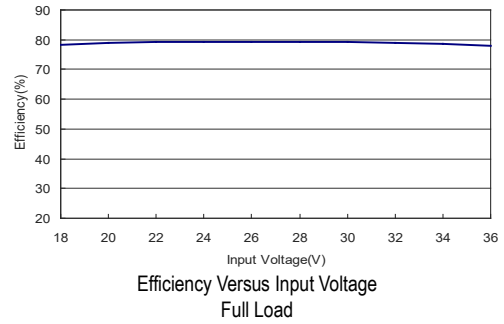

Efficiency Versus Input Voltage Full Load

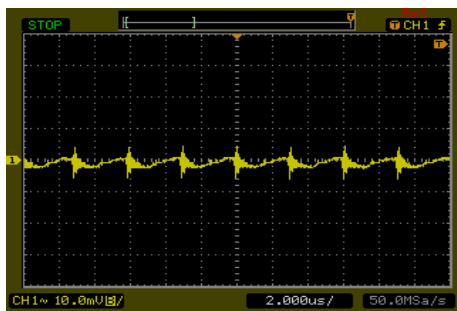

Typical Output Ripple and Noise  
 $V_{in}=V_{in\ nom}$ ; Full Load

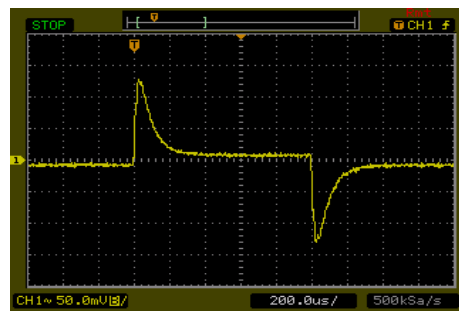

Transient Response to Dynamic Load Change  
 from 100% to 75% of Full Load;  $V_{in}=V_{in\ nom}$

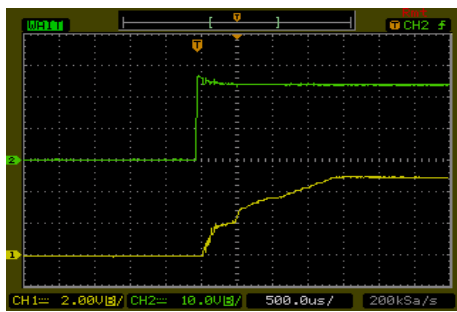

Typical Input Start-Up and Output Rise Characteristic  
 $V_{in}=V_{in\ nom}$ ; Full Load

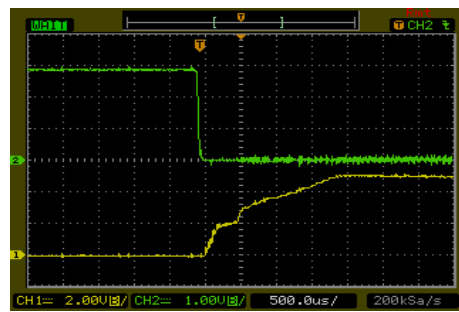

ON/OFF Voltage Start-Up and Output Rise Characteristic  
 $V_{in}=V_{in\ nom}$ ; Full Load

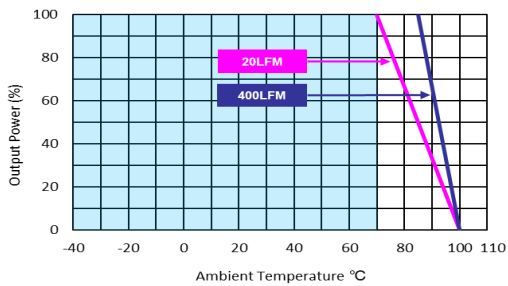

Derating Output Current Versus Ambient Temperature and Airflow  
 $V_{in}=V_{in\ nom}$

Characteristic Curves

All test conditions are at 25°C The figures are identical for MCW03-24S12

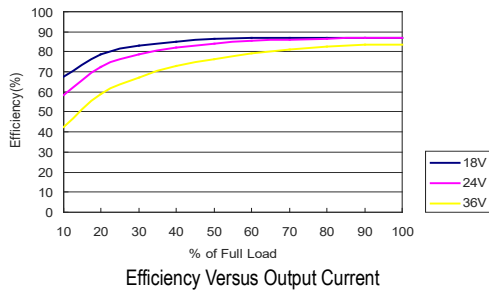

Efficiency Versus Output Current

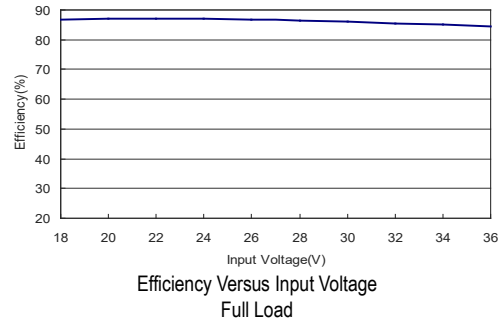

Efficiency Versus Input Voltage Full Load

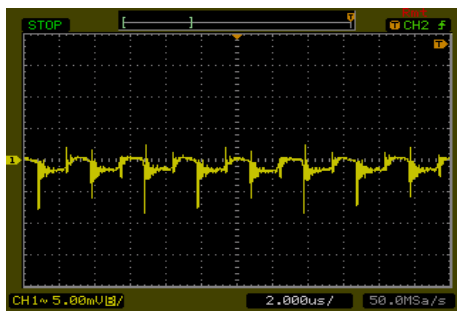

Typical Output Ripple and Noise  
 $V_{in}=V_{in\ nom}$  ; Full Load

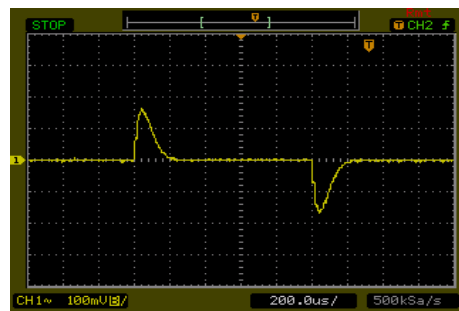

Transient Response to Dynamic Load Change  
from 100% to 75% of Full Load ;  $V_{in}=V_{in\ nom}$

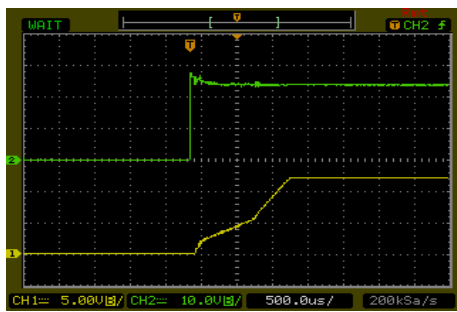

Typical Input Start-Up and Output Rise Characteristic  
 $V_{in}=V_{in\ nom}$  ; Full Load

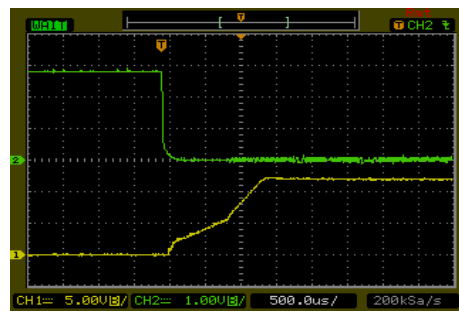

ON/OFF Voltage Start-Up and Output Rise Characteristic  
 $V_{in}=V_{in\ nom}$  ; Full Load

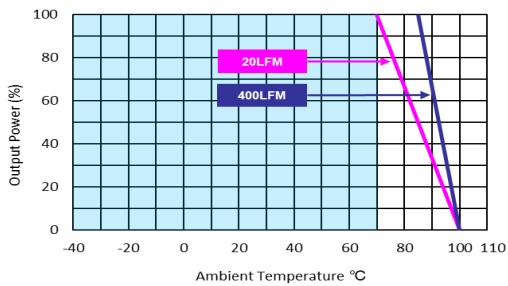

Derating Output Current Versus Ambient Temperature and Airflow  
 $V_{in}=V_{in\ nom}$

Characteristic Curves

All test conditions are at 25°C The figures are identical for MCW03-24S15

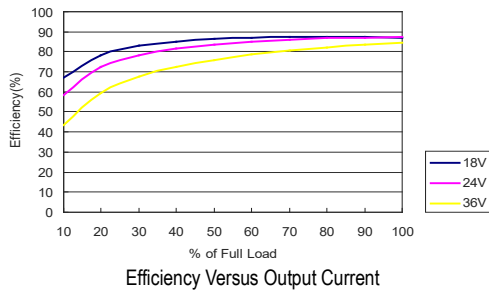

Efficiency Versus Output Current

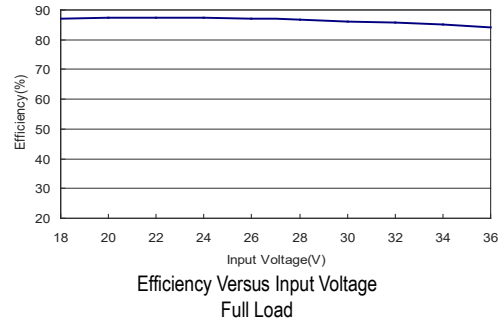

Efficiency Versus Input Voltage Full Load

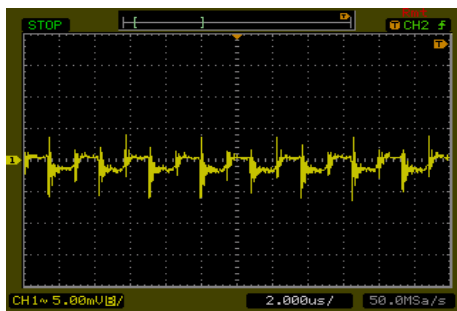

Typical Output Ripple and Noise  
 $V_{in}=V_{in\ nom}$  ; Full Load

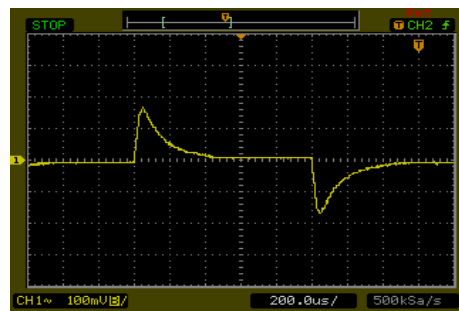

Transient Response to Dynamic Load Change  
from 100% to 75% of Full Load ;  $V_{in}=V_{in\ nom}$

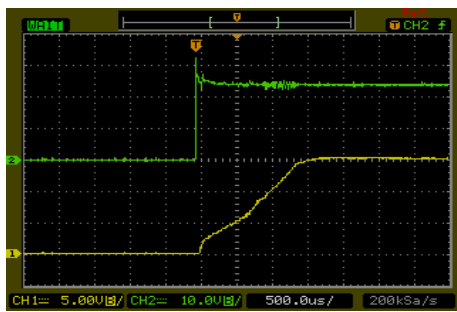

Typical Input Start-Up and Output Rise Characteristic  
 $V_{in}=V_{in\ nom}$  ; Full Load

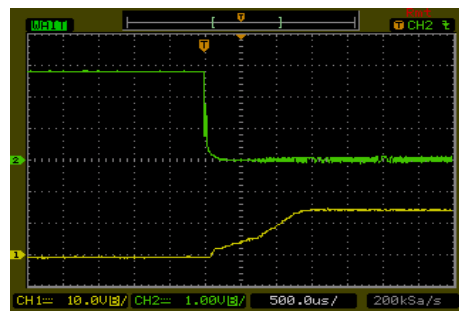

ON/OFF Voltage Start-Up and Output Rise Characteristic  
 $V_{in}=V_{in\ nom}$  ; Full Load

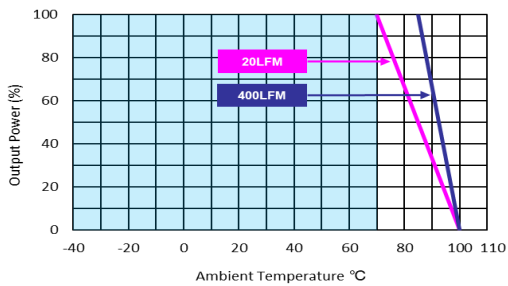

Derating Output Current Versus Ambient Temperature and Airflow  
 $V_{in}=V_{in\ nom}$

Characteristic Curves

All test conditions are at 25°C The figures are identical for MCW03-24D05

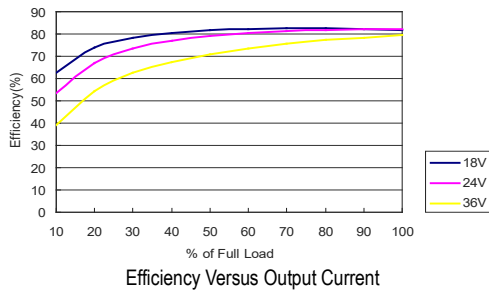

Efficiency Versus Output Current

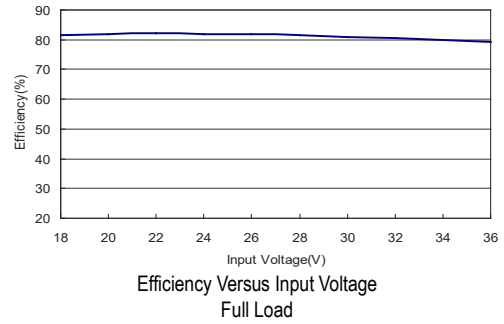

Efficiency Versus Input Voltage Full Load

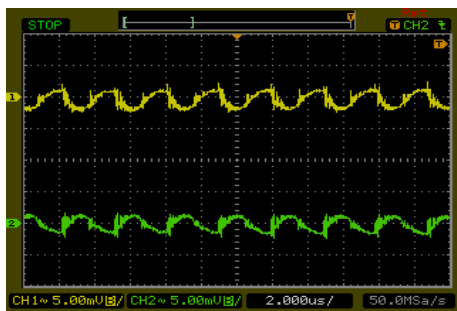

Typical Output Ripple and Noise  
 $V_{in}=V_{in\ nom}$ ; Full Load

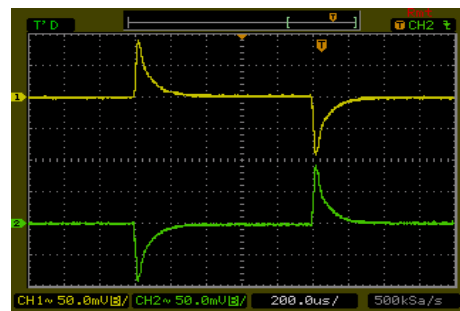

Transient Response to Dynamic Load Change  
 from 100% to 75% of Full Load;  $V_{in}=V_{in\ nom}$

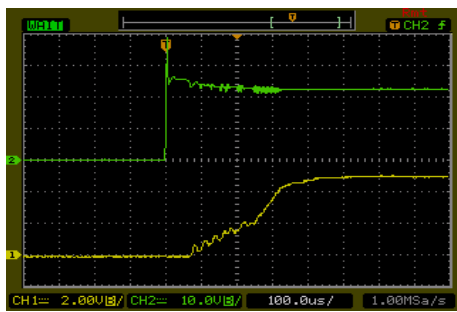

Typical Input Start-Up and Output Rise Characteristic  
 $V_{in}=V_{in\ nom}$ ; Full Load

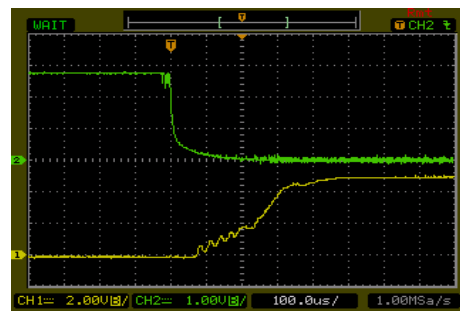

ON/OFF Voltage Start-Up and Output Rise Characteristic  
 $V_{in}=V_{in\ nom}$ ; Full Load

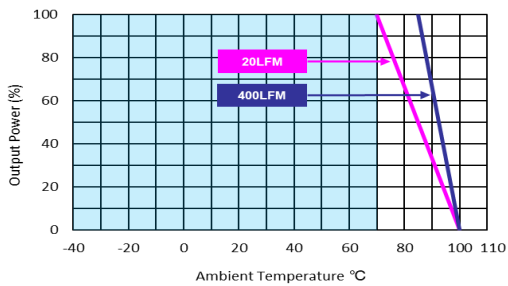

Derating Output Current Versus Ambient Temperature and Airflow  
 $V_{in}=V_{in\ nom}$

Characteristic Curves

All test conditions are at 25°C The figures are identical for MCW03-24D12

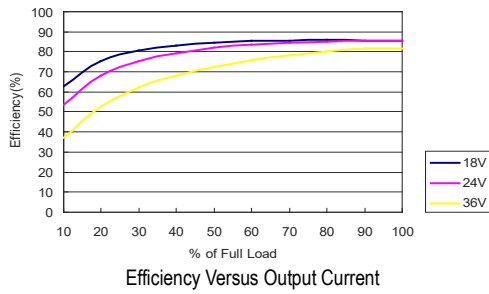

Efficiency Versus Output Current

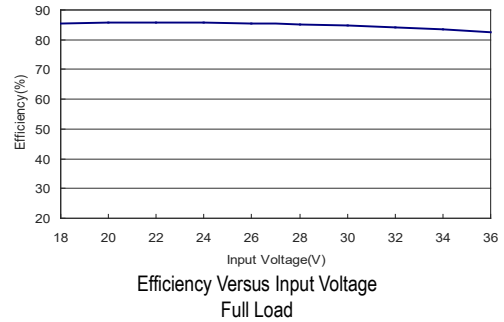

Efficiency Versus Input Voltage Full Load

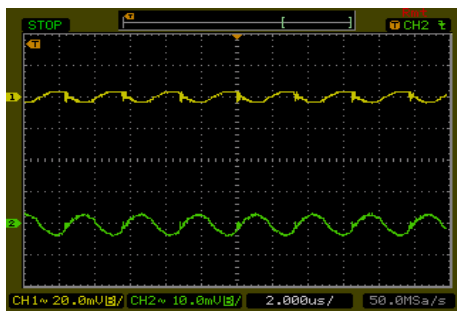

Typical Output Ripple and Noise  
 $V_{in}=V_{in\ nom}$  ; Full Load

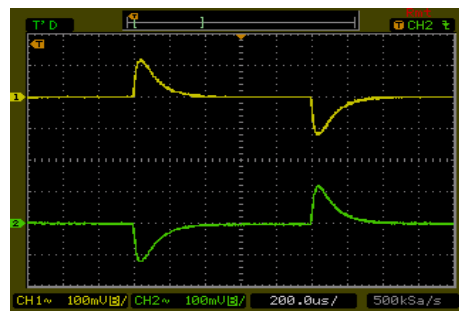

Transient Response to Dynamic Load Change  
 from 100% to 75% of Full Load ;  $V_{in}=V_{in\ nom}$

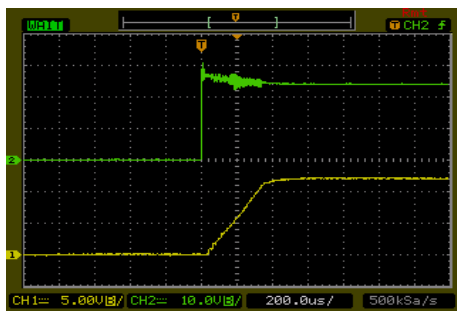

Typical Input Start-Up and Output Rise Characteristic  
 $V_{in}=V_{in\ nom}$  ; Full Load

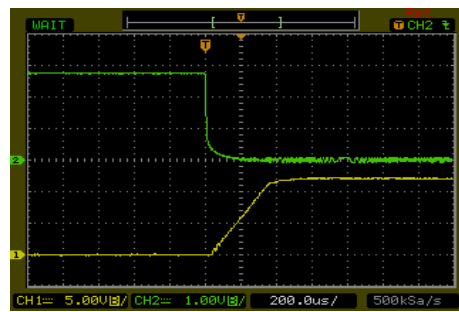

ON/OFF Voltage Start-Up and Output Rise Characteristic  
 $V_{in}=V_{in\ nom}$  ; Full Load

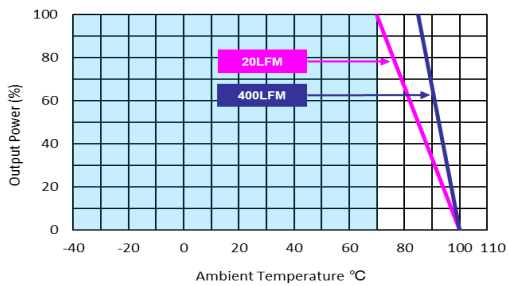

Derating Output Current Versus Ambient Temperature and Airflow  
 $V_{in}=V_{in\ nom}$

Characteristic Curves

All test conditions are at 25°C The figures are identical for MCW03-24D15

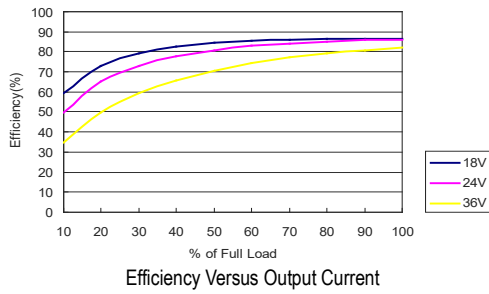

Efficiency Versus Output Current

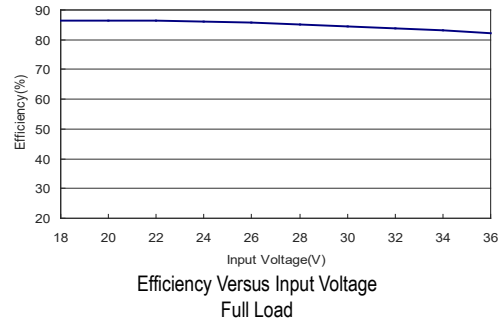

Efficiency Versus Input Voltage Full Load

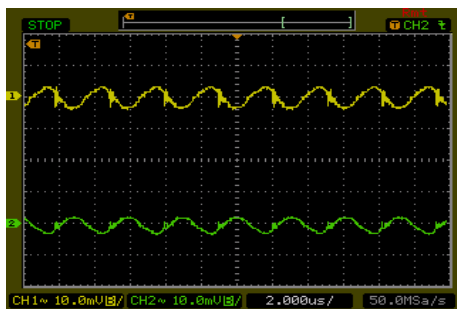

Typical Output Ripple and Noise  
 $V_{in}=V_{in\ nom}$ ; Full Load



Transient Response to Dynamic Load Change  
from 100% to 75% of Full Load;  $V_{in}=V_{in\ nom}$

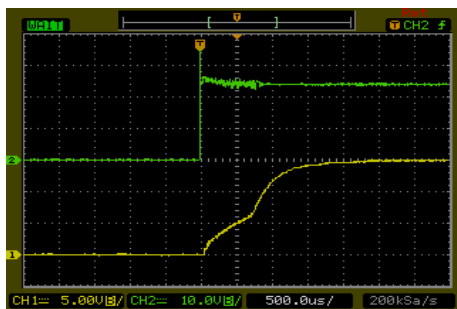

Typical Input Start-Up and Output Rise Characteristic  
 $V_{in}=V_{in\ nom}$ ; Full Load

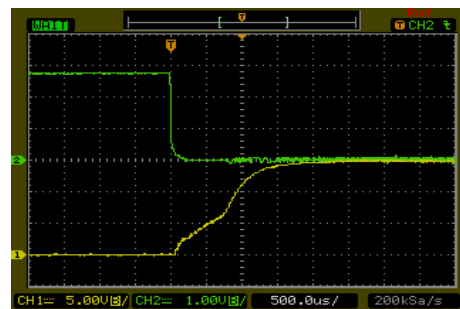

ON/OFF Voltage Start-Up and Output Rise Characteristic  
 $V_{in}=V_{in\ nom}$ ; Full Load

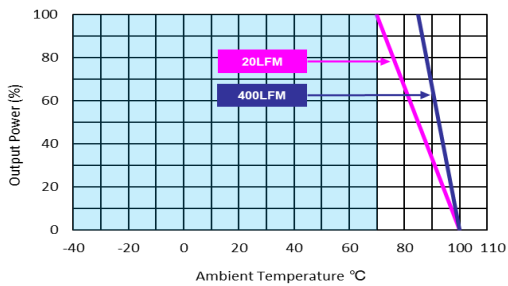

Derating Output Current Versus Ambient Temperature and Airflow  
 $V_{in}=V_{in\ nom}$



Characteristic Curves

All test conditions are at 25°C The figures are identical for MCW03-48S033

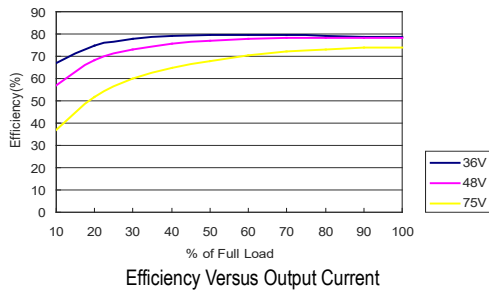

Efficiency Versus Output Current

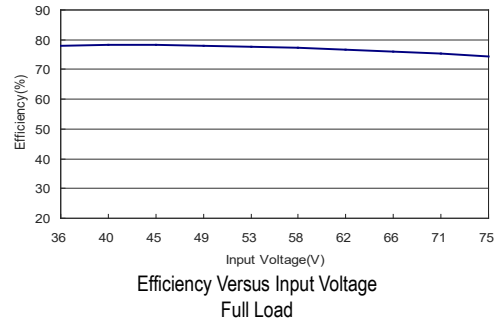

Efficiency Versus Input Voltage Full Load

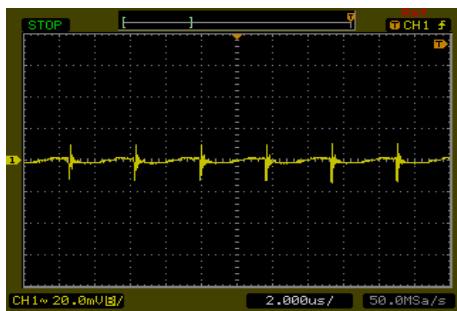

Typical Output Ripple and Noise  
 $V_{in}=V_{in\ nom}$ ; Full Load

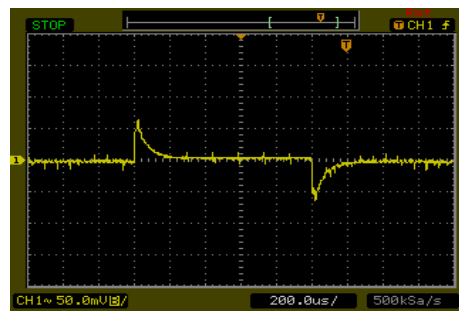

Transient Response to Dynamic Load Change  
from 100% to 75% of Full Load ;  $V_{in}=V_{in\ nom}$

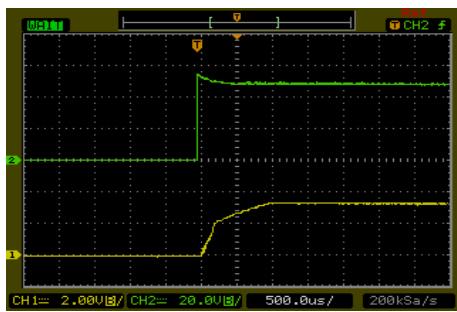

Typical Input Start-Up and Output Rise Characteristic  
 $V_{in}=V_{in\ nom}$ ; Full Load

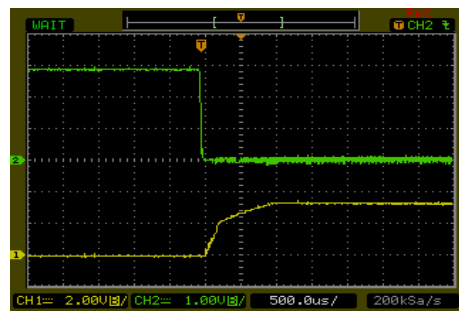

ON/OFF Voltage Start-Up and Output Rise Characteristic  
 $V_{in}=V_{in\ nom}$ ; Full Load

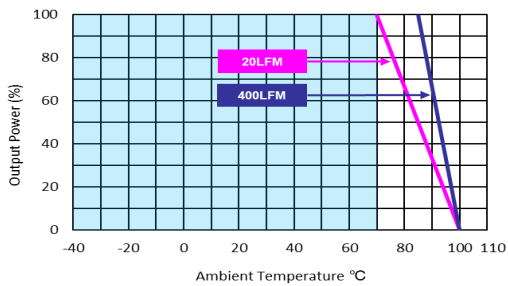

Derating Output Current Versus Ambient Temperature and Airflow  
 $V_{in}=V_{in\ nom}$

Characteristic Curves

All test conditions are at 25°C The figures are identical for MCW03-48S05

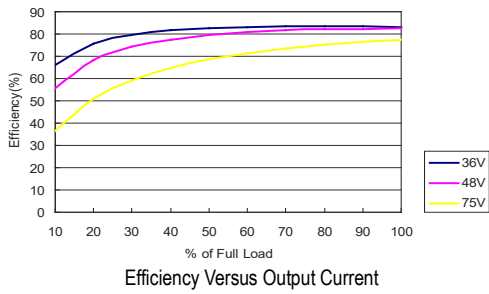

Efficiency Versus Output Current

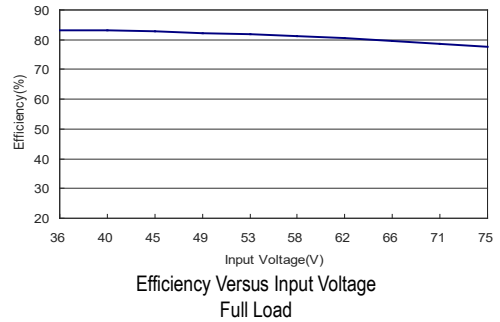

Efficiency Versus Input Voltage Full Load

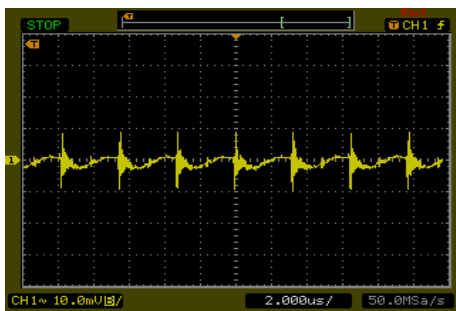

Typical Output Ripple and Noise  
 $V_{in}=V_{in\ nom}$  ; Full Load

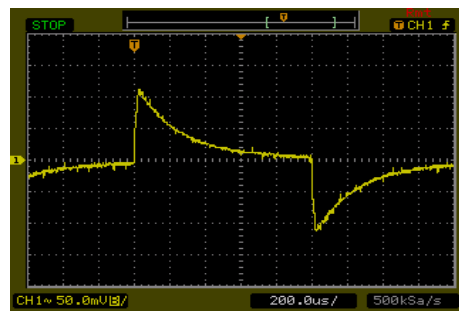

Transient Response to Dynamic Load Change  
from 100% to 75% of Full Load ;  $V_{in}=V_{in\ nom}$

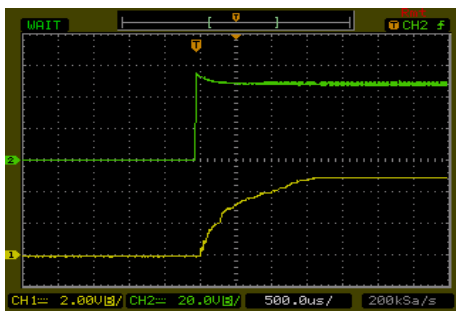

Typical Input Start-Up and Output Rise Characteristic  
 $V_{in}=V_{in\ nom}$  ; Full Load

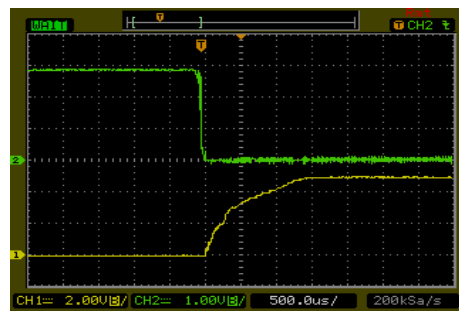

ON/OFF Voltage Start-Up and Output Rise Characteristic  
 $V_{in}=V_{in\ nom}$  ; Full Load

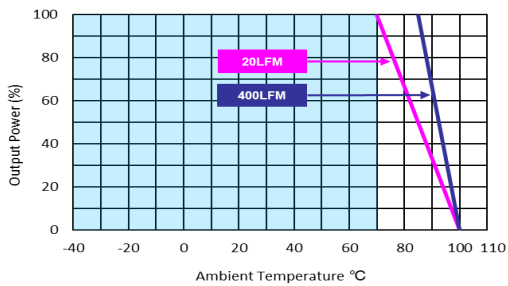

Derating Output Current Versus Ambient Temperature and Airflow  
 $V_{in}=V_{in\ nom}$

Characteristic Curves

All test conditions are at 25°C The figures are identical for MCW03-48S12

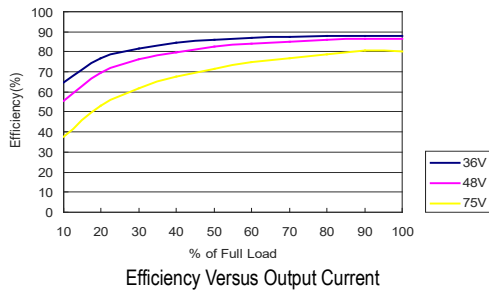

Efficiency Versus Output Current

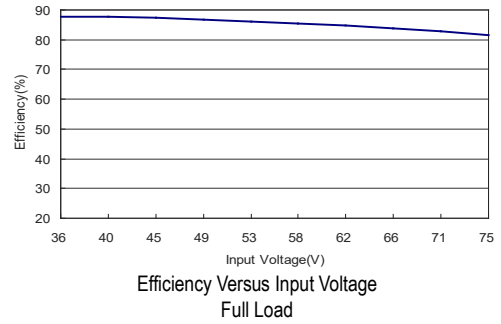

Efficiency Versus Input Voltage Full Load

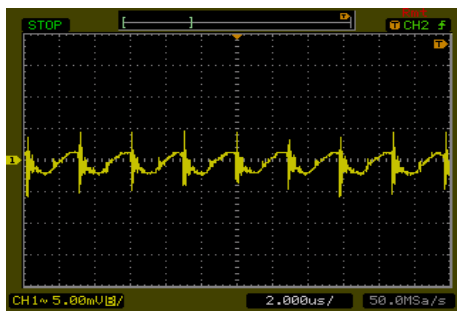

Typical Output Ripple and Noise  
 $V_{in}=V_{in\ nom}$  ; Full Load

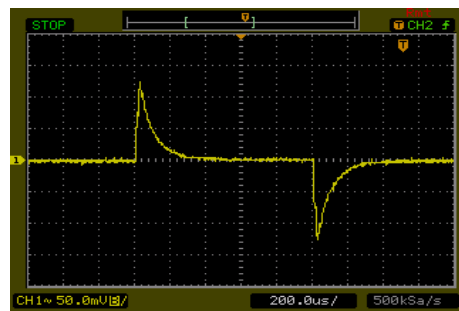

Transient Response to Dynamic Load Change  
 from 100% to 75% of Full Load ;  $V_{in}=V_{in\ nom}$

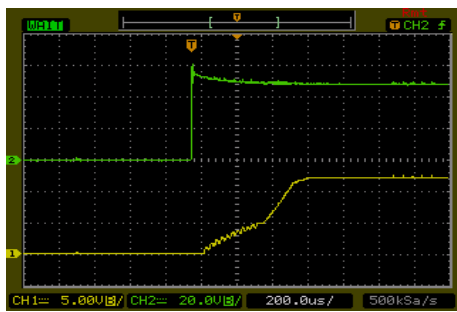

Typical Input Start-Up and Output Rise Characteristic  
 $V_{in}=V_{in\ nom}$  ; Full Load

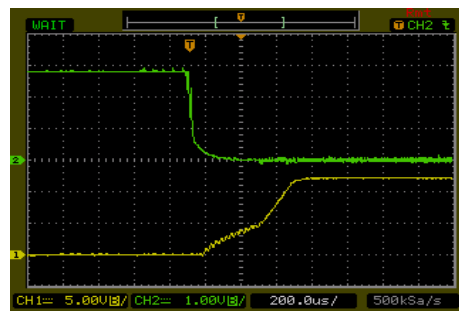

ON/OFF Voltage Start-Up and Output Rise Characteristic  
 $V_{in}=V_{in\ nom}$  ; Full Load

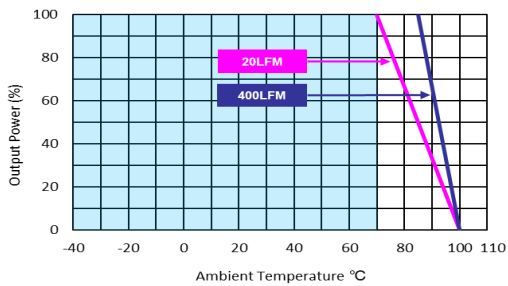

Derating Output Current Versus Ambient Temperature and Airflow  
 $V_{in}=V_{in\ nom}$

Characteristic Curves

All test conditions are at 25°C The figures are identical for MCW03-48S15

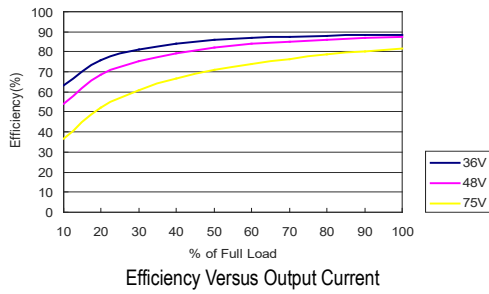

Efficiency Versus Output Current

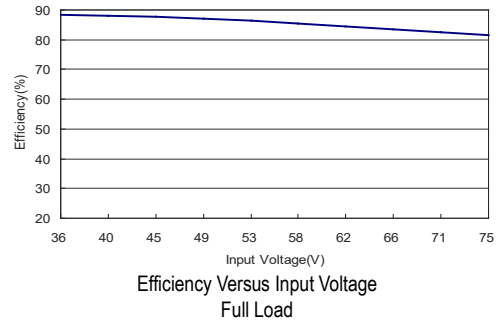

Efficiency Versus Input Voltage Full Load

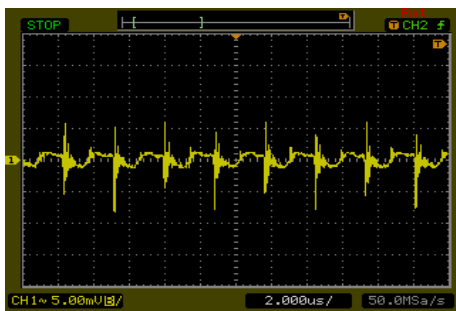

Typical Output Ripple and Noise  
 $V_{in}=V_{in\ nom}$  ; Full Load

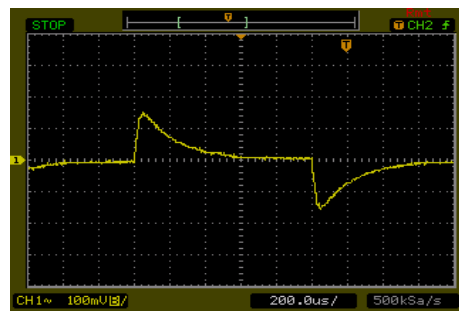

Transient Response to Dynamic Load Change  
from 100% to 75% of Full Load ;  $V_{in}=V_{in\ nom}$

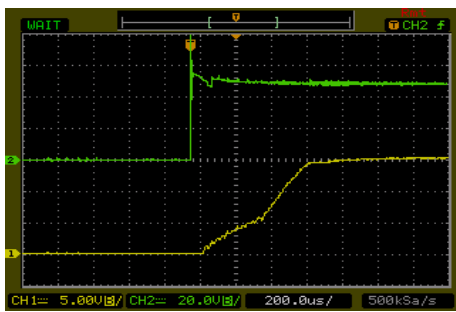

Typical Input Start-Up and Output Rise Characteristic  
 $V_{in}=V_{in\ nom}$  ; Full Load

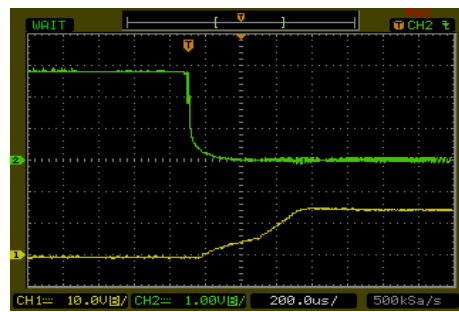

ON/OFF Voltage Start-Up and Output Rise Characteristic  
 $V_{in}=V_{in\ nom}$  ; Full Load

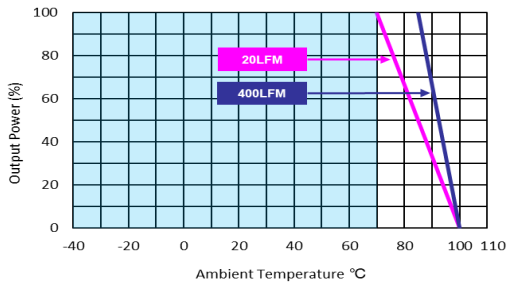

Derating Output Current Versus Ambient Temperature and Airflow  
 $V_{in}=V_{in\ nom}$

Characteristic Curves

All test conditions are at 25°C The figures are identical for MCW03-48D05

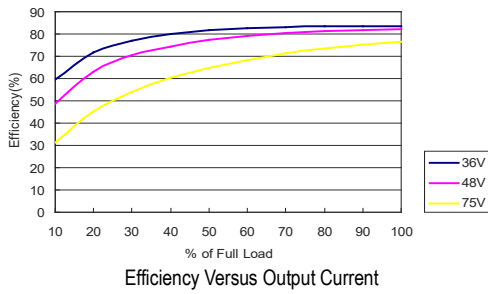

Efficiency Versus Output Current

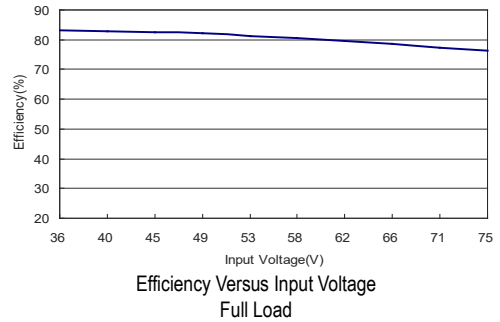

Efficiency Versus Input Voltage Full Load

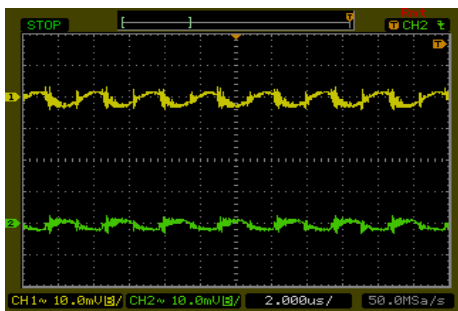

Typical Output Ripple and Noise  
 $V_{in}=V_{in\ nom}$  ; Full Load

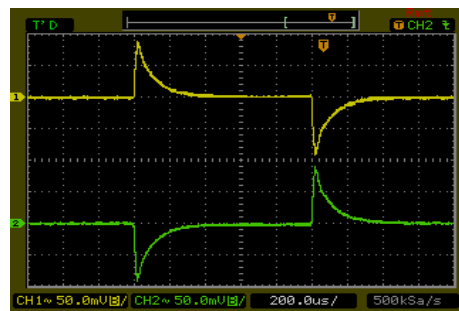

Transient Response to Dynamic Load Change  
 from 100% to 75% of Full Load ;  $V_{in}=V_{in\ nom}$

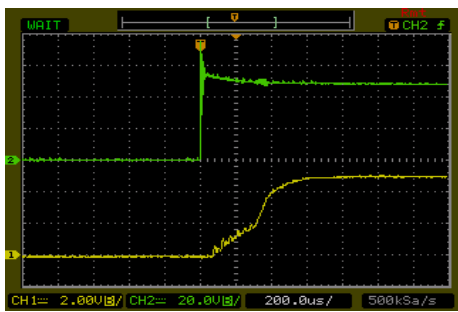

Typical Input Start-Up and Output Rise Characteristic  
 $V_{in}=V_{in\ nom}$  ; Full Load

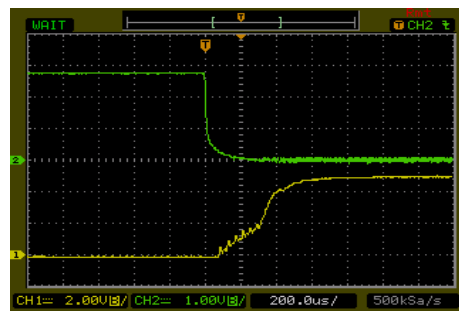

ON/OFF Voltage Start-Up and Output Rise Characteristic  
 $V_{in}=V_{in\ nom}$  ; Full Load

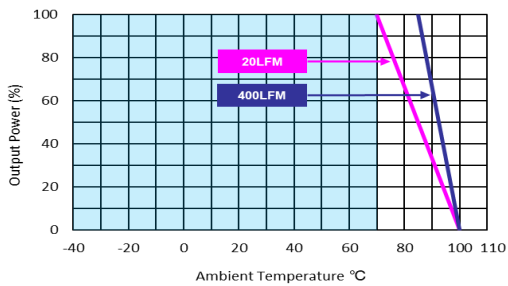

Derating Output Current Versus Ambient Temperature and Airflow  
 $V_{in}=V_{in\ nom}$

Characteristic Curves

All test conditions are at 25°C The figures are identical for MCW03-48D12

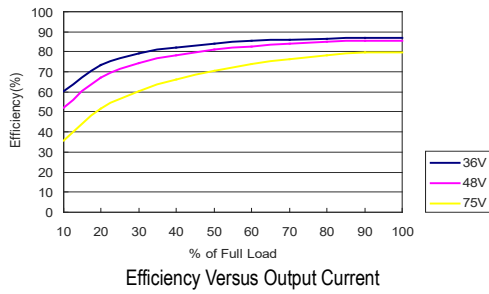

Efficiency Versus Output Current

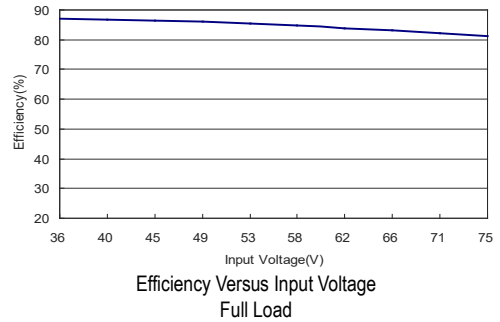

Efficiency Versus Input Voltage Full Load

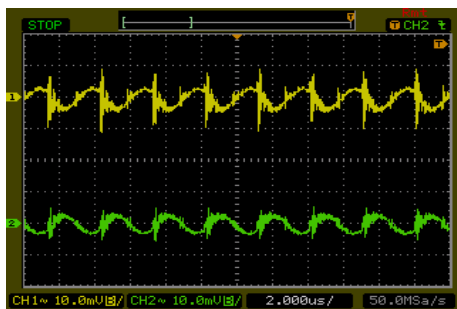

Typical Output Ripple and Noise  
 $V_{in}=V_{in\ nom}$ ; Full Load

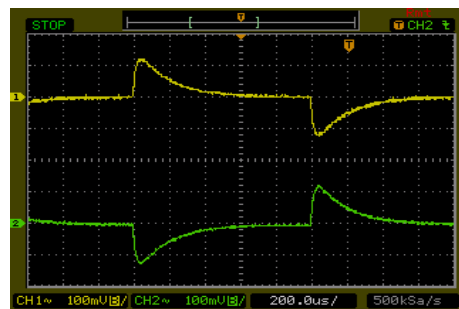

Transient Response to Dynamic Load Change  
from 100% to 75% of Full Load;  $V_{in}=V_{in\ nom}$

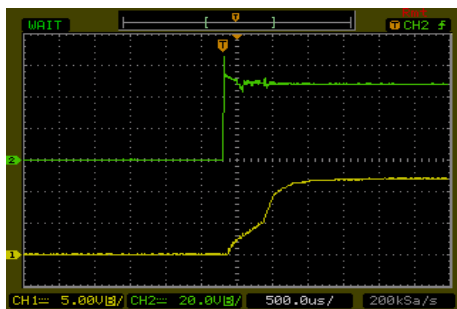

Typical Input Start-Up and Output Rise Characteristic  
 $V_{in}=V_{in\ nom}$ ; Full Load

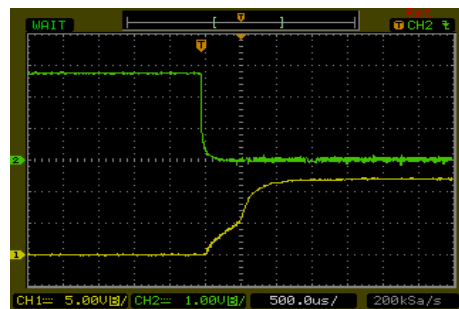

ON/OFF Voltage Start-Up and Output Rise Characteristic  
 $V_{in}=V_{in\ nom}$ ; Full Load

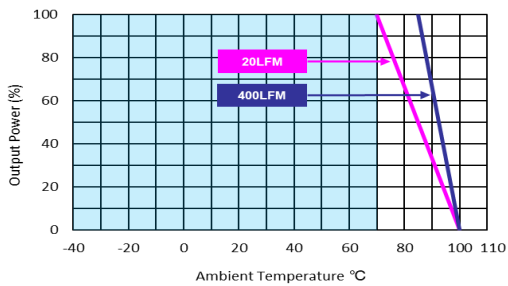

Derating Output Current Versus Ambient Temperature and Airflow  
 $V_{in}=V_{in\ nom}$

Characteristic Curves

All test conditions are at 25°C The figures are identical for MCW03-48D15

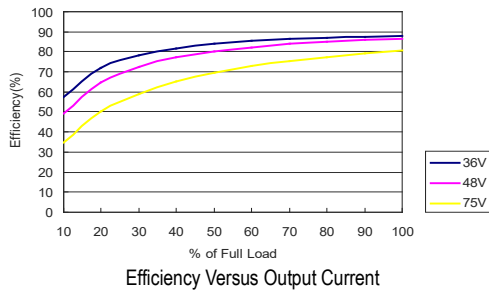

Efficiency Versus Output Current

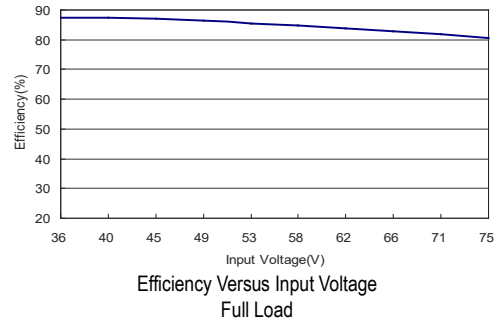

Efficiency Versus Input Voltage Full Load

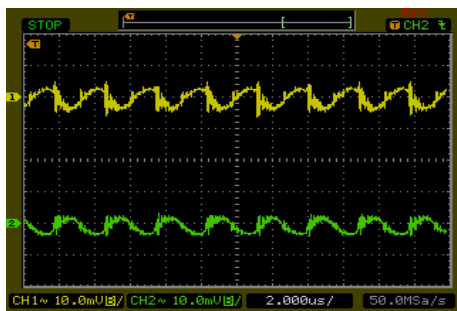

Typical Output Ripple and Noise  
 $V_{in}=V_{in\ nom}$ ; Full Load



Transient Response to Dynamic Load Change  
from 100% to 75% of Full Load;  $V_{in}=V_{in\ nom}$

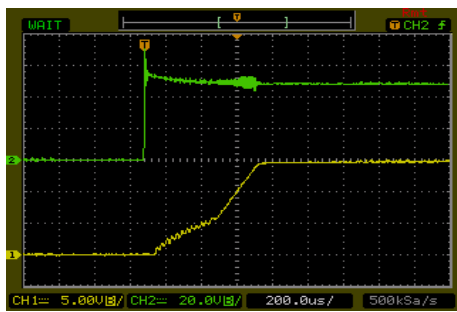

Typical Input Start-Up and Output Rise Characteristic  
 $V_{in}=V_{in\ nom}$ ; Full Load

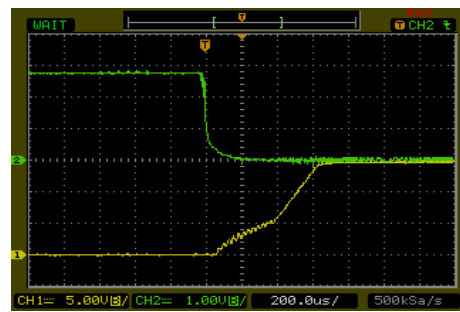

ON/OFF Voltage Start-Up and Output Rise Characteristic  
 $V_{in}=V_{in\ nom}$ ; Full Load

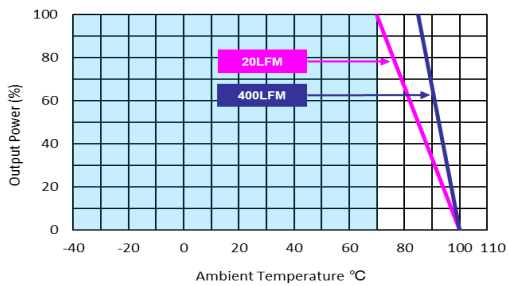

Derating Output Current Versus Ambient Temperature and Airflow  
 $V_{in}=V_{in\ nom}$

Package Specifications

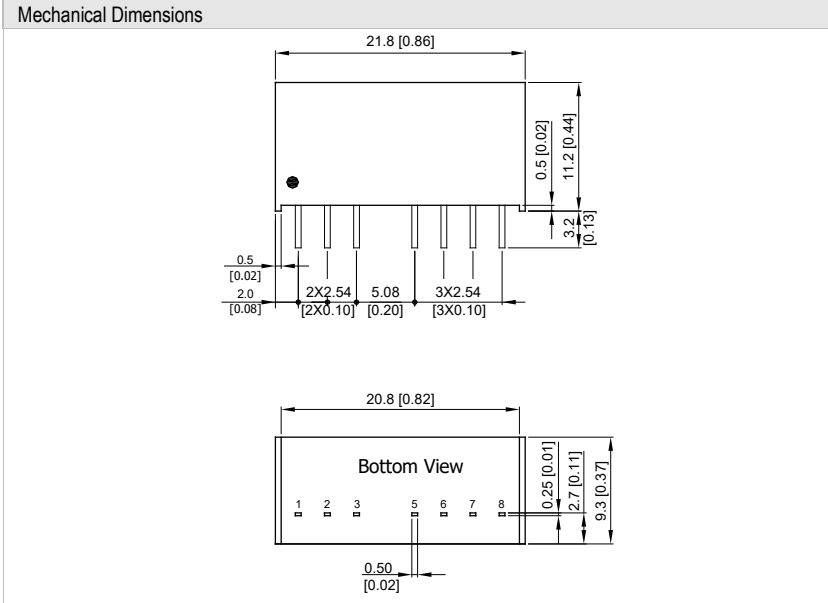

Pin Connections

Pin	Single Output	Dual Output
1	-Vin	-Vin
2	+Vin	+Vin
3	Remote On/Off	Remote On/Off
5	NC	NC
6	+Vout	+Vout
7	-Vout	Common
8	NC	-Vout

NC: No Connection

- ▶ All dimensions in mm (inches)
- ▶ Tolerance: X.X±0.5 (X.XX±0.02)  
X.XX±0.25 ( X.XXX±0.01)
- ▶ Pins ±0.1(±0.004)

Physical Characteristics

Case Size	: 21.8x9.3x11.2 mm (0.86x0.37x0.44 inches)
Case Material	: Non-Conductive Black Plastic (flammability to UL 94V-0 rated)
Pin Material	: Alloy 42
Weight	: 4.8g

Recommended Pad Layout for Single & Dual Output Converter

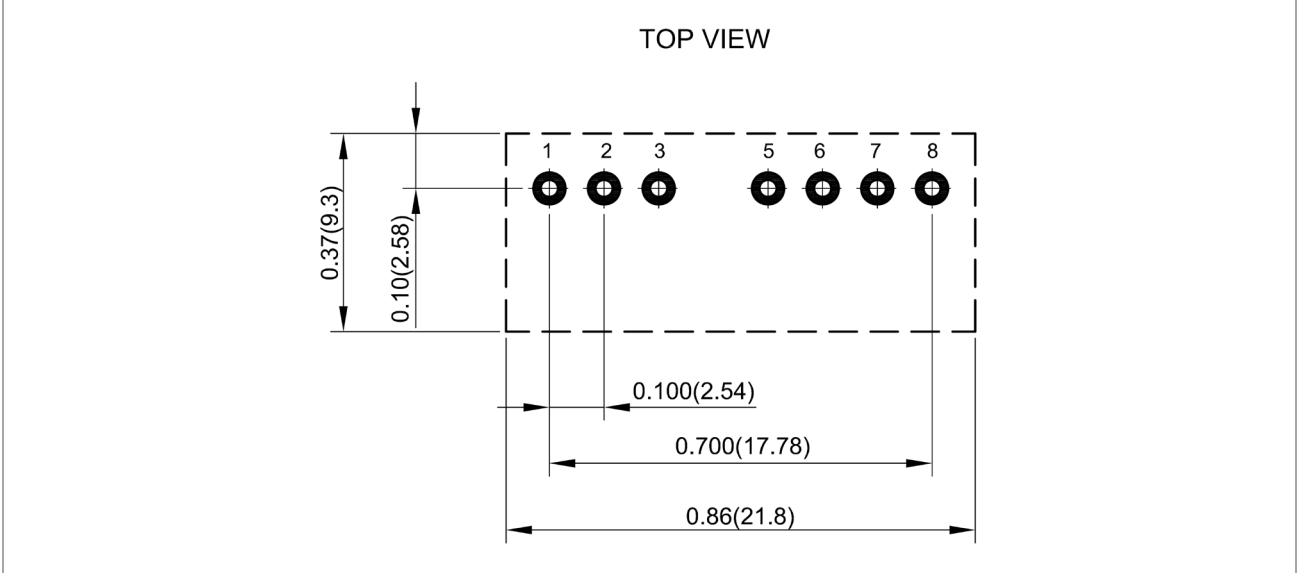



**Test Setup**

**Peak-to-Peak Output Noise Measurement Test**

Use a  $C_{out}$  0.47 $\mu$ F ceramic capacitor. Scope measurement should be made by using a BNC socket, measurement bandwidth is 0-20 MHz. Position the load between 50 mm and 75 mm from the DC-DC Converter.

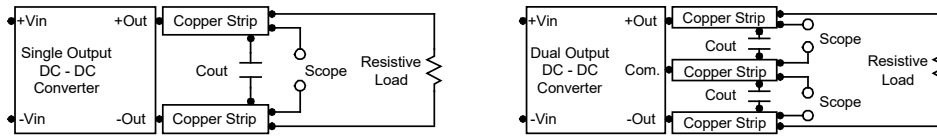

**Technical Notes**

**Remote On/Off**

Negative logic remote on/off turns the module off during a logic high voltage on the remote on/off pin, and on during a logic low. To turn the power module on and off, the user must supply a switch to control the voltage between the on/off terminal and the -Vin terminal. The switch can be an open collector or equivalent. A logic high is 2.7V to 15V. A logic low is under 0.6 VDC or open circuit, drops down to 0VDC by 2mV/°C. The maximum sink current at on/off terminal during a logic low is 1 mA. The maximum allowable leakage current of the switch at on/off terminal= (under 0.6VDC or open circuit) is 1mA.

**Maximum Capacitive Load**

The MCW03 series has limitation of maximum connected capacitance at the output. The power module may be operated in current limiting mode during start-up, affecting the ramp-up and the startup time. The maximum capacitance can be found in the data sheet.

**Overcurrent Protection**

To provide protection in a fault (output overload) condition, the unit is equipped with internal current limiting circuitry and can endure current limiting for an unlimited duration. At the point of current-limit inception, the unit shifts from voltage control to current control. The unit operates normally once the output current is brought back into its specified range.

**Input Source Impedance**

The power module should be connected to a low ac-impedance input source. Highly inductive source impedances can affect the stability of the power module. In applications where power is supplied over long lines and output loading is high, it may be necessary to use a capacitor at the input to ensure startup. Capacitor mounted close to the power module helps ensure stability of the unit, it is commended to use a good quality low Equivalent Series Resistance (ESR < 1.0 $\Omega$  at 100 kHz) capacitor of a 8.2 $\mu$ F for the 5V input device, a 3.3 $\mu$ F for the 12V input devices and a 1.5 $\mu$ F for the 24V and 48V devices.

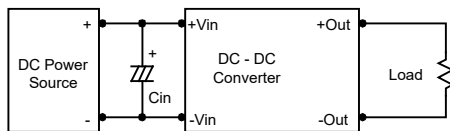

**Output Ripple Reduction**

A good quality low ESR capacitor placed as close as practicable across the load will give the best ripple and noise performance. To reduce output ripple, it is recommended to use 3.3 $\mu$ F capacitors at the output.

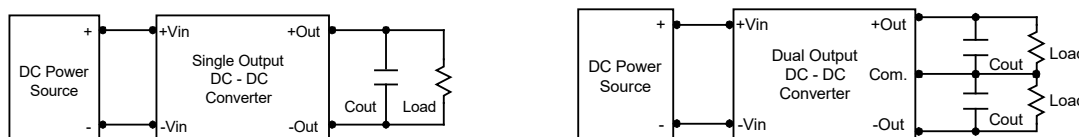

**Thermal Considerations**

Many conditions affect the thermal performance of the power module, such as orientation, airflow over the module and board spacing. To avoid exceeding the maximum temperature rating of the components inside the power module, the case temperature must be kept below 105°C. The derating curves are determined from measurements obtained in a test setup.

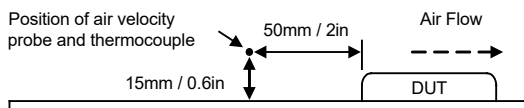

**Remote ON/OFF Implementation**

The positive logic remote ON/OFF control circuit is included.

Turns the module ON during logic High on the ON/Off pin and turns OFF during logic Low. The ON/OFF input signal (Von/off) that referenced to GND. If not using the remote on/off feature, please open circuit between on/off pin and -Vin pin to turn the module on.

The negative logic remote ON/OFF control circuit is included.

Turns the module ON during logic Low on the On/Off pin and turns OFF during logic High. The On/Off pin is an open collector/drain logic input signal (Von/off) that referenced to GND. If not using the remote on/off feature. Please short circuit between on/off pin and -Vin pin to turn the module on.

Remote ON/OFF implementation

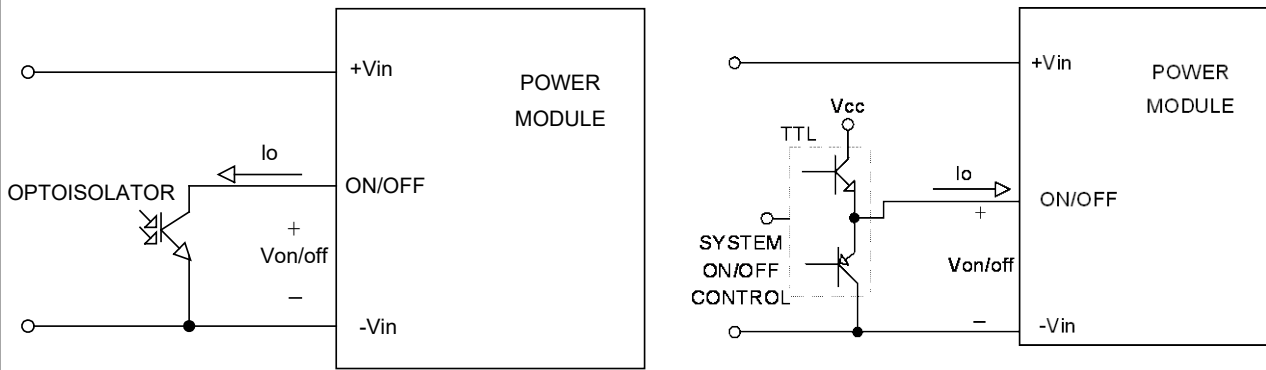

Isolated-Closure Remote ON/OFF

Level Control Using TTL Output

**Packaging Information**

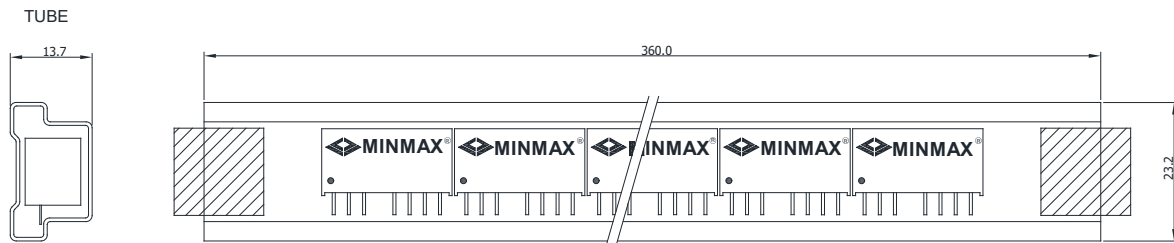

unit:mm  
10 PCS per TUBE

**Wave Soldering Considerations**

Lead free wave solder profile

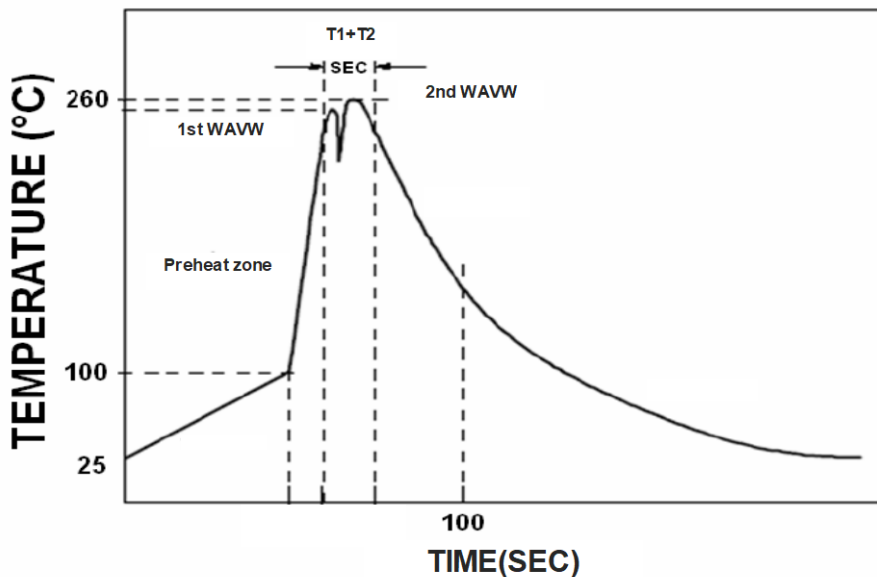

Zone	Reference Parameter
Preheat	Rise temp. speed : 3°C/sec max.
zone	Preheat temp. : 100~130°C
Actual	Peak temp. : 250~260°C
heating	Peak time(T1+T2) : 4~6 sec

Reference Solder: Sn-Ag-Cu : Sn-Cu : Sn-Ag

Hand Welding: Soldering iron : Power 60W

Welding Time: 2~4 sec

Temp.: 380~400°C

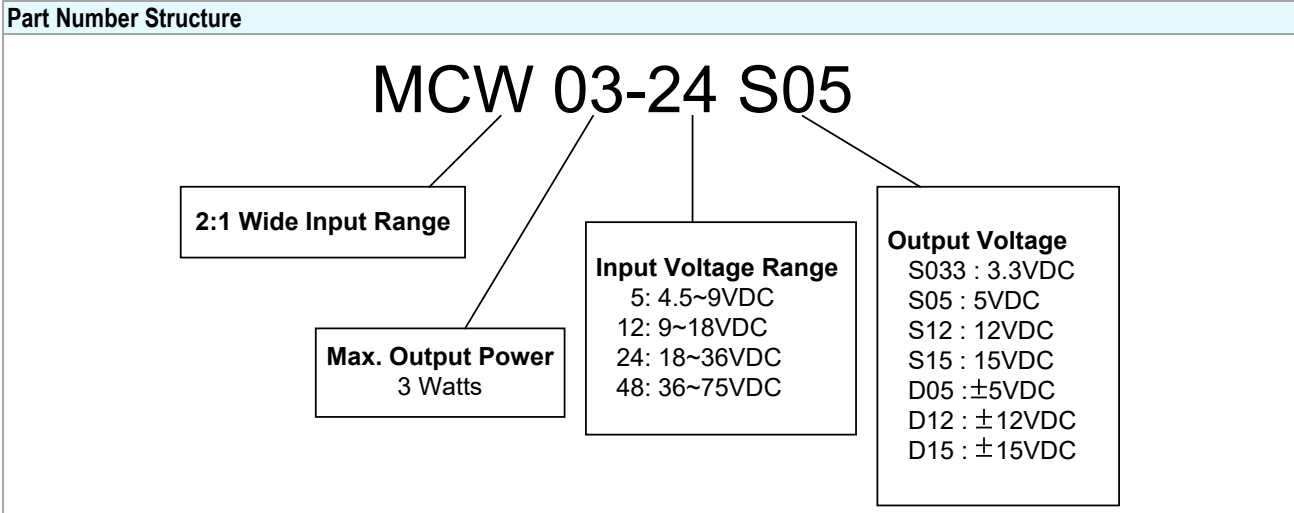

**MTBF and Reliability**

The MTBF of MCW03 series of DC-DC converters has been calculated using

MIL-HDBK 217F NOTICE2, Operating Temperature 25°C, Ground Benign.

Model	MTBF	Unit
MCW03-05S033	1,235,483	Hours
MCW03-05S05	1,352,265	
MCW03-05S12	1,402,525	
MCW03-05S15	1,379,310	
MCW03-05D05	1,235,483	
MCW03-05D12	1,413,627	
MCW03-05D15	1,393,146	
MCW03-12S033	1,219,363	
MCW03-12S05	1,352,265	
MCW03-12S12	1,382,361	
MCW03-12S15	1,379,310	
MCW03-12D05	1,219,363	
MCW03-12D12	1,393,146	
MCW03-12D15	1,373,249	
MCW03-24S033	1,211,534	
MCW03-24S05	1,324,153	
MCW03-24S12	1,372,495	
MCW03-24S15	1,369,488	
MCW03-24D05	1,211,534	
MCW03-24D12	1,383,126	
MCW03-24D15	1,383,126	
MCW03-48S033	1,203,659	
MCW03-48S05	1,314,924	
MCW03-48S12	1,362,769	
MCW03-48S15	1,359,804	
MCW03-48D05	1,203,659	
MCW03-48D12	1,373,249	
MCW03-48D15	1,373,249	