



MINMAX[®]

MCWI08 Series

Electric Characteristic Note

MCWI08 Series EC Note

DC-DC CONVERTER 8W, Regulated Output, SIP Package

Features

- ▶ Smallest Encapsulated 8W Converter
- ▶ Industrial Standard SIP-8 Package
- ▶ Ultra-wide 4 : 1 Input Voltage Range
- ▶ Fully Regulated Output Voltage
- ▶ I/O Isolation 1500 VDC
- ▶ Wide Operating Temperature Range
- ▶ No Min. Load Requirement
- ▶ Very Low No Load Power Consumption
- ▶ Under-voltage, Overload and Short Circuit Protection
- ▶ Remote On/Off Control
- ▶ UL/cUL/IEC/EN 62368-1 Safety Approval (Pending)



Applications

- ▶ Distributed power architectures
- ▶ Workstations
- ▶ Computer equipment
- ▶ Communications equipment

Product Overview

The MCWI08 series is a compact 8W isolated DC-DC converter designed in a high-density SIP-8 package, delivering a power density of 52W/in³. It features an ultra-wide 4:1 input voltage range with models supporting 4.5–18VDC, 9–36VDC, or 18–75VDC, offering design flexibility across various industrial and embedded applications.

The series provides precisely regulated output voltages of 5V, 12V, 15V, 24V, ±12V, and ±15V, with 1500VDC input-to-output isolation ensuring robust performance in demanding environments. Operation is supported over an extended temperature range with no minimum load requirement and ultra-low no-load and standby power consumption for high efficiency in energy-sensitive systems.

Integrated protection features include under Voltage Shutdown, output overload, and continuous short-circuit protection. A remote on/off control function enables flexible system-level power management.

Certified to UL/cUL/IEC/EN 62368-1 safety standards, the MCWI08 series is ideal for space-constrained industrial, control, and embedded system designs requiring reliable and efficient DC-DC power conversion.

Table of contents

Model Selection Guide	P2	Recommended Pad Layout.....	P23
Input Specifications.....	P2	Test Setup.....	P24
Remote On/Off Control.....	P2	Technical Notes	P24
Output Specifications.....	P3	Remote ON/OFF Implementation	P25
General Specifications.....	P3	Packaging Information for Tube	P25
EMC Specifications.....	P3	Wave Soldering Considerations	P26
Environmental Specifications	P3	Hand Welding Parameter	P26
Characteristic Curves	P5	Part Number Structure	P27
Package Specifications	P23	MTBF and Reliability	P27

Model Selection Guide

Model Number	Input Voltage (Range)	Output Voltage	Output Current	Input Current		Max. capacitive Load	Efficiency (typ.)
				Max.	@No Load		
	VDC	VDC	mA	mA(typ.)	mA(typ.)	μF	%
MCWI08-12S05	12 (4.5 ~ 18)	5	1600	758	20	3300	88
MCWI08-12S12		12	665	756		560	88
MCWI08-12S15		15	535	760		390	88
MCWI08-12S24		24	335	761		150	88
MCWI08-12D12		±12	±335	761		330#	88
MCWI08-12D15		±15	±265	753		180#	88
MCWI08-24S05	24 (9 ~ 36)	5	1600	379	10	3300	88
MCWI08-24S12		12	665	378		560	88
MCWI08-24S15		15	535	380		390	88
MCWI08-24S24		24	335	381		150	88
MCWI08-24D12		±12	±335	381		330#	88
MCWI08-24D15		±15	±265	376		180#	88
MCWI08-48S05	48 (18 ~ 75)	5	1600	189	8	3300	88
MCWI08-48S12		12	665	189		560	88
MCWI08-48S15		15	535	190		390	88
MCWI08-48S24		24	335	190		150	88
MCWI08-48D12		±12	±335	190		330#	88
MCWI08-48D15		±15	±265	188		180#	88

For each output

Input Specifications

Parameter	Conditions / Model	Min.	Typ.	Max.	Unit
Input Surge Voltage (1 sec. max.)	12V Input Models	-0.7	---	25	VDC
	24V Input Models	-0.7	---	50	
	48V Input Models	-0.7	---	100	
Start-Up Threshold Voltage	12V Input Models	---	---	4.5	
	24V Input Models	---	---	9	
	48V Input Models	---	---	18	
Under Voltage Shutdown	12V Input Models	---	4	---	
	24V Input Models	---	8	---	
	48V Input Models	---	16	---	
Start Up Time (Power On)	Nominal Vin and Constant Resistive Load	---	30	---	ms
Input Filter	All Models	Internal Capacitor			

Remote On/Off Control

Parameter	Conditions	Min.	Typ.	Max.	Unit
Converter On	3.5V ~ 12V or Open Circuit				
Converter Off	0V ~ 1.2V or Short Circuit				
Control Input Current (on)	Vctrl = 5.0V	---	---	0.5	mA
Control Input Current (off)	Vctrl = 0V	---	---	-0.5	mA
Control Common	Referenced to Negative Input				
Standby Input Current	Nominal Vin	---	2.5	---	mA

Output Specifications							
Parameter	Conditions / Model			Min.	Typ.	Max.	Unit
Output Voltage Setting Accuracy				---	---	±1.0	%Vnom.
Output Voltage Balance	Dual Output, Balanced Loads			---	±1.0	±2.0	%
Line Regulation	Vin=Min. to Max. @Full Load			---	±0.2	±0.8	%
Load Regulation	Io=0% to 100%			---	---	±1.0	%
Load Cross Regulation (Dual Output Models)	Asymmetrical Load 25/100% Full Load			---	---	±5.0	%
Minimum Load	No minimum Load Requirement						
Ripple & Noise	0-20 MHz Bandwidth	5V Output	Measured with a 1µF/50V MLCC	---	80	100	mV _{P-P}
		Other Output		---	100	140	mV _{P-P}
Transient Recovery Time	25% Load Step Change			---	---	500	µs
Transient Response Deviation				---	±3	±5	%
Temperature Coefficient				---	±0.01	±0.02	%/°C
Over Load Protection	Hiccup			110	---	180	%
Overshoot				---	---	5	%
Short Circuit Protection	Continuous, Automatic Recovery (Hiccup Mode 1 Hz typ.)						

General Specifications							
Parameter	Conditions			Min.	Typ.	Max.	Unit
I/O Isolation Voltage	60 Seconds			1500	---	---	VDC
	1 Second			1800	---	---	VDC
I/O Isolation Resistance	500 VDC			1000	---	---	MΩ
I/O Isolation Capacitance	100kHz, 1V			---	---	1500	pF
Switching Frequency				---	350	---	kHz
MTBF (calculated)	MIL-HDBK-217F@25°C, Ground Benign			2,001,209	---	---	Hours
Safety Approvals (Pending)	UL/cUL 62368-1 recognition (UL certificate), IEC/EN 62368-1 (CB-report)						

EMC Specifications					
Parameter	Standards & Level			Performance	
EMI _(e)	Conduction	EN 55032		With external components	Class A
	Radiation				
EMS _(e)	EN 55035				
	ESD	Direct discharge		Indirect discharge HCP & VCP	
		EN 61000-4-2 Air ± 8kV		Contact ± 6kV	
	Radiated immunity	EN 61000-4-3 10V/m			A
	Fast transient	EN 61000-4-4 ±2kV			A
	Surge	EN 61000-4-5 ±2kV			A
	Conducted immunity	EN 61000-4-6 10Vrms			A
PFMF	EN 61000-4-8 100A/m for Continuous; 1000 A/m for 1 s			A	

Environmental Specifications				
Parameter	Model	Min.	Max.	Unit
Operating Ambient Temperature Range Nominal Vin, Load 100% Inom. (for Power Derating see relative Derating Curves)	5V Output	-40	+70	°C
	Other Output		+75	
Case Temperature		---	+105	°C
Storage Temperature Range		-50	+125	°C
Humidity (non condensing)		---	95	% rel. H
Lead Temperature (1.5mm from case for 10Sec.)		---	260	°C

Notes

- 1 Specifications typical at $T_a=+25^{\circ}\text{C}$, resistive load, nominal input voltage and rated output current unless otherwise noted.
- 2 Transient recovery time is measured to within 1% error band for a step change in output load of 75% to 100%.
- 3 We recommend to protect the converter by a slow blow fuse in the input supply line.
- 4 Other input and output voltage may be available, please contact MINMAX.
- 5 **It is necessary to parallel a capacitor across the input pins under hot-swap operation. Minimum Capacitance: 68 μF / 100V KZE.**
- 6 The external components might be required to meet EMI/EMS standard for some of test items. Please contact MINMAX for the solution in detail.
- 7 Specifications are subject to change without notice.
- 8 The repeated high voltage isolation testing of the converter can degrade isolation capability, to a lesser or greater degree depending on materials, construction, environment and reflow solder process. Any material is susceptible to eventual chemical degradation when subject to very high applied voltages thus implying that the number of tests should be strictly limited. We therefore strongly advise against repeated high voltage isolation testing, but if it is absolutely required, that the voltage be reduced by 20% from specified test voltage. Furthermore, the high voltage isolation capability after reflow solder process should be evaluated as it is applied on system.

Characteristic Curves

All test conditions are at 25°C The figures are identical for MCWI08-12S05

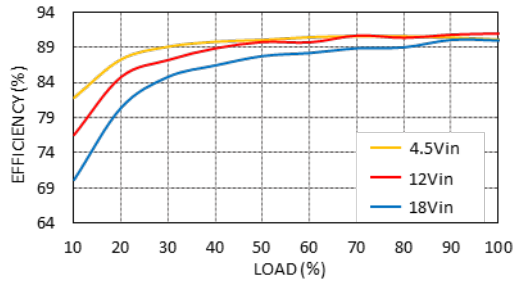

Efficiency Versus Output Current

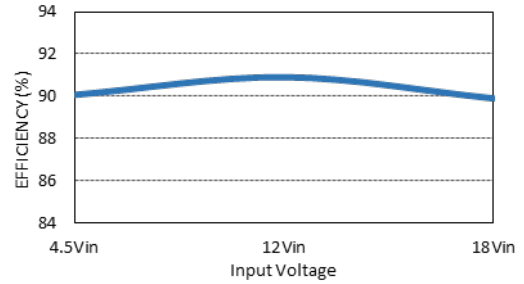

Efficiency Versus Input Voltage Full Load

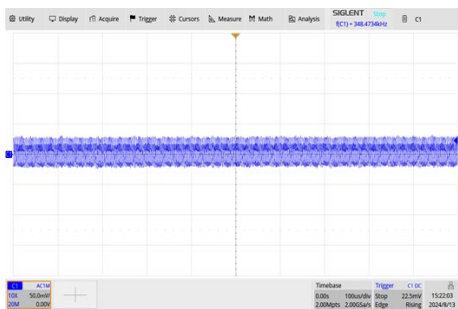

Typical Output Ripple and Noise
 $V_{in}=V_{in\ nom}$; Full Load

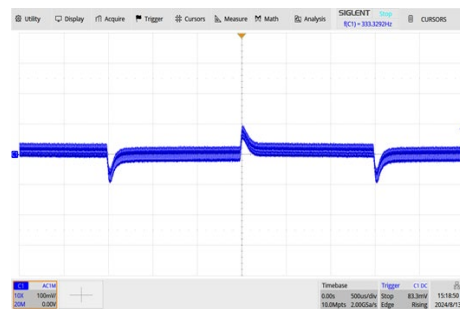

Transient Response to Dynamic Load Change
from 100% to 75% of Full Load; $V_{in}=V_{in\ nom}$

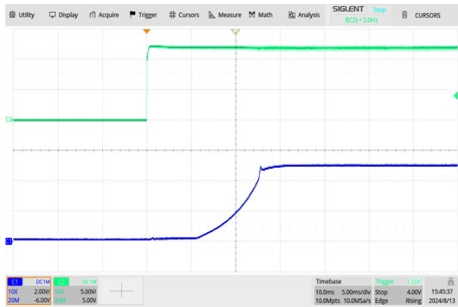

Typical Input Start-Up and Output Rise Characteristic
 $V_{in}=V_{in\ nom}$; Full Load

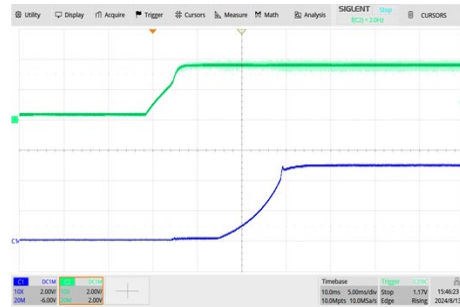

ON/OFF Voltage Start-Up and Output Rise Characteristic
 $V_{in}=V_{in\ nom}$; Full Load

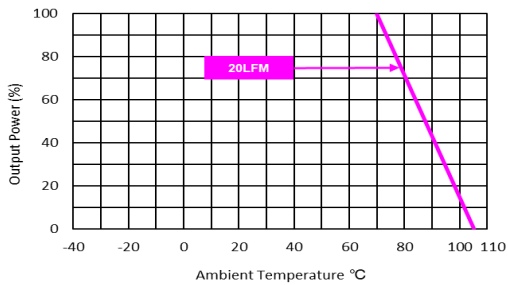

Derating Output Current Versus Ambient Temperature
 $V_{in}=V_{in\ nom}$

Characteristic Curves

All test conditions are at 25°C The figures are identical for MCWI08-12S12

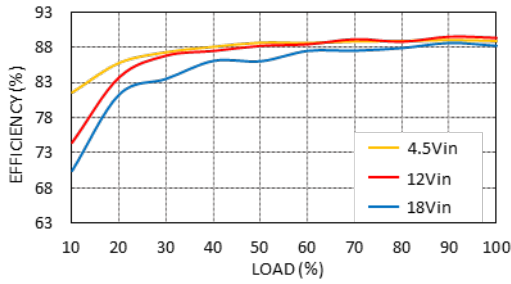

Efficiency Versus Output Current

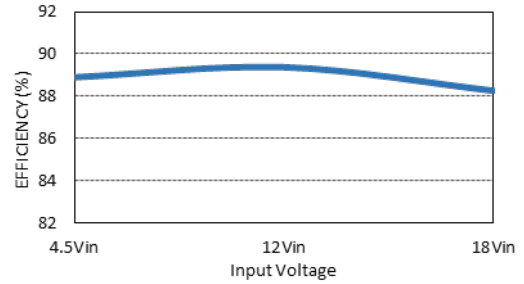

Efficiency Versus Input Voltage Full Load

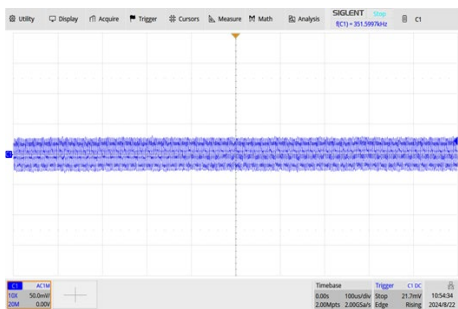

Typical Output Ripple and Noise
 $V_{in}=V_{in\ nom}$; Full Load

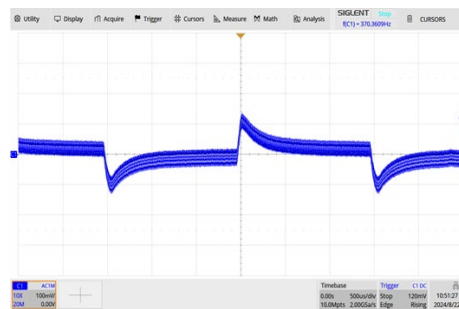

Transient Response to Dynamic Load Change
from 100% to 75% of Full Load; $V_{in}=V_{in\ nom}$

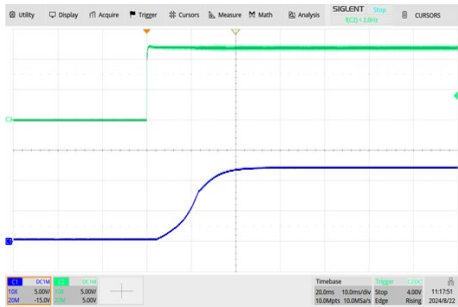

Typical Input Start-Up and Output Rise Characteristic
 $V_{in}=V_{in\ nom}$; Full Load

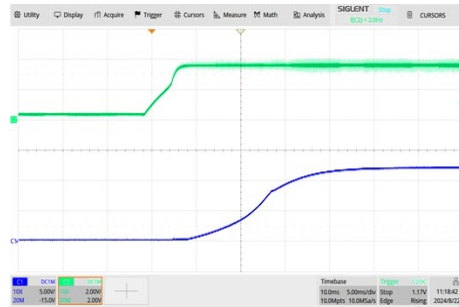

ON/OFF Voltage Start-Up and Output Rise Characteristic
 $V_{in}=V_{in\ nom}$; Full Load

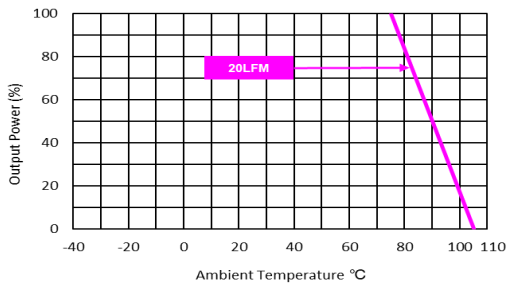

Derating Output Current Versus Ambient Temperature
 $V_{in}=V_{in\ nom}$

Characteristic Curves

All test conditions are at 25°C The figures are identical for MCWI08-12S15

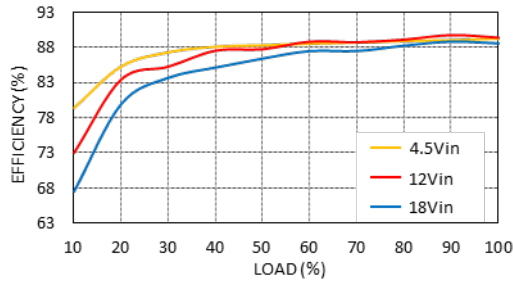

Efficiency Versus Output Current

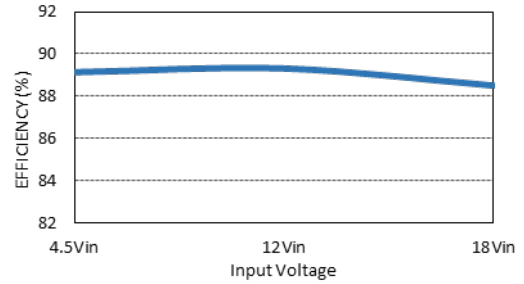

Efficiency Versus Input Voltage Full Load



Typical Output Ripple and Noise
 $V_{in}=V_{in\ nom}$; Full Load

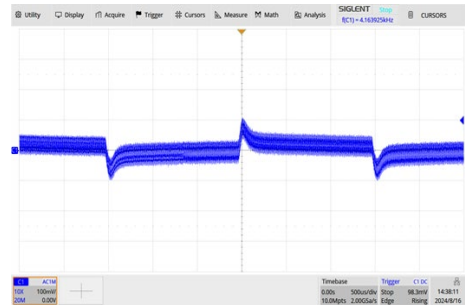

Transient Response to Dynamic Load Change
from 100% to 75% of Full Load; $V_{in}=V_{in\ nom}$

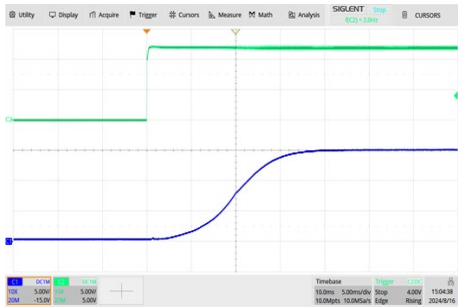

Typical Input Start-Up and Output Rise Characteristic
 $V_{in}=V_{in\ nom}$; Full Load

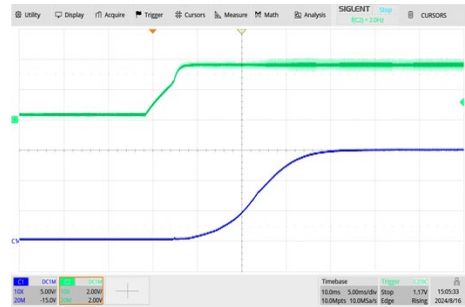

ON/OFF Voltage Start-Up and Output Rise Characteristic
 $V_{in}=V_{in\ nom}$; Full Load

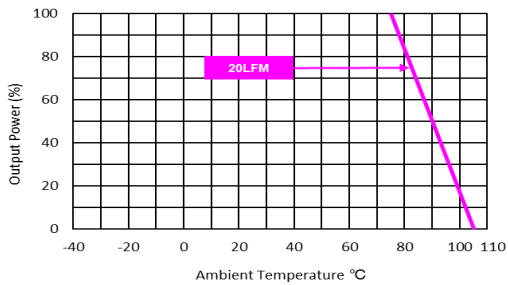

Derating Output Current Versus Ambient Temperature
 $V_{in}=V_{in\ nom}$

Characteristic Curves

All test conditions are at 25°C The figures are identical for MCWI08-12S24

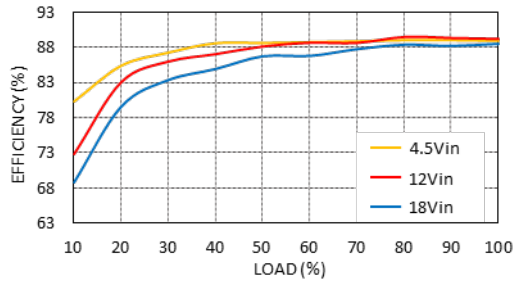

Efficiency Versus Output Current

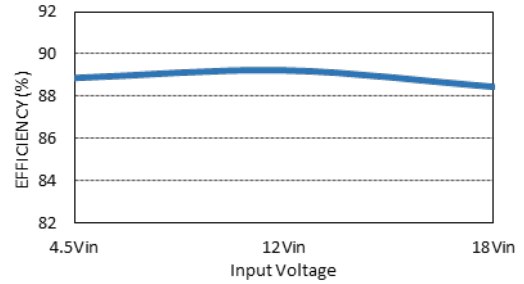

Efficiency Versus Input Voltage Full Load

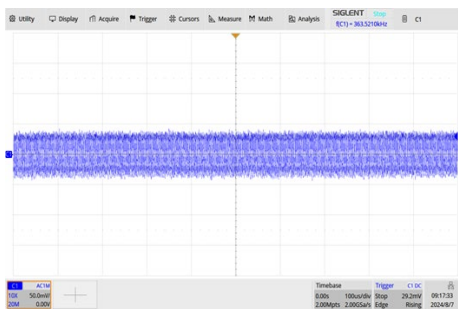

Typical Output Ripple and Noise
 $V_{in}=V_{in\ nom}$; Full Load

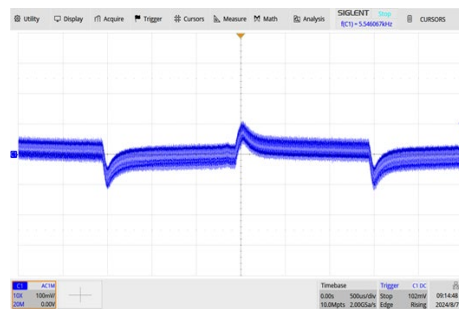

Transient Response to Dynamic Load Change
from 100% to 75% of Full Load; $V_{in}=V_{in\ nom}$

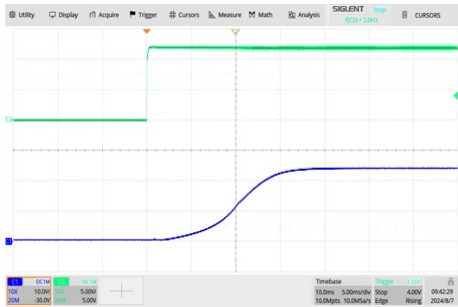

Typical Input Start-Up and Output Rise Characteristic
 $V_{in}=V_{in\ nom}$; Full Load

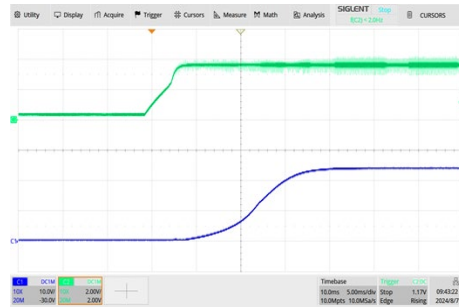

ON/OFF Voltage Start-Up and Output Rise Characteristic
 $V_{in}=V_{in\ nom}$; Full Load

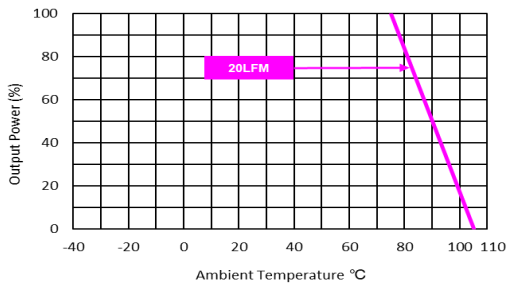

Derating Output Current Versus Ambient Temperature
 $V_{in}=V_{in\ nom}$

Characteristic Curves

All test conditions are at 25°C The figures are identical for MCWI08-12D12

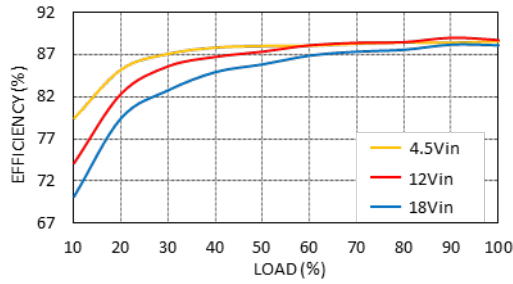

Efficiency Versus Output Current

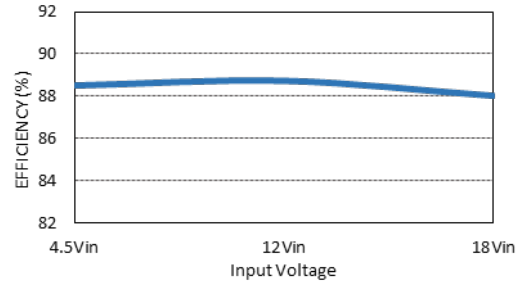

Efficiency Versus Input Voltage Full Load

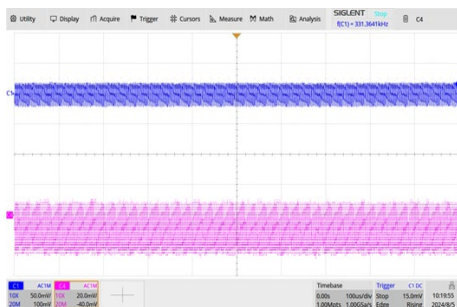

Typical Output Ripple and Noise
 $V_{in}=V_{in\ nom}$; Full Load

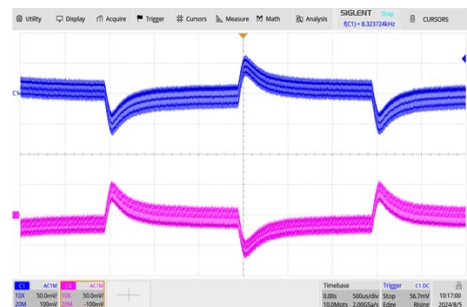

Transient Response to Dynamic Load Change
from 100% to 75% of Full Load; $V_{in}=V_{in\ nom}$

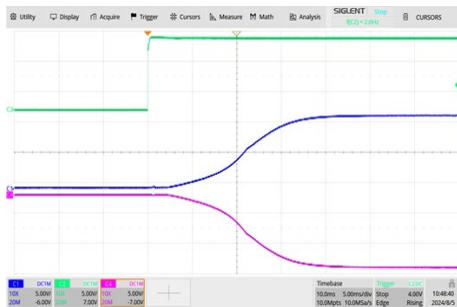

Typical Input Start-Up and Output Rise Characteristic
 $V_{in}=V_{in\ nom}$; Full Load

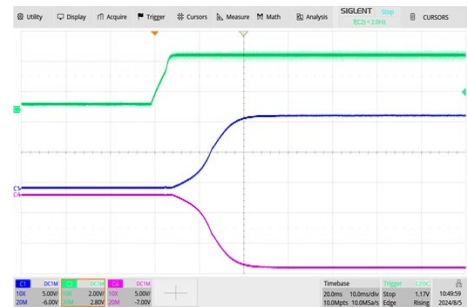

ON/OFF Voltage Start-Up and Output Rise Characteristic
 $V_{in}=V_{in\ nom}$; Full Load

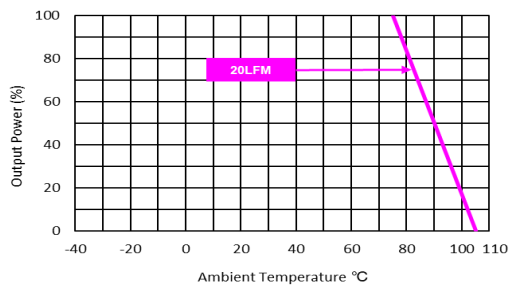

Derating Output Current Versus Ambient Temperature
 $V_{in}=V_{in\ nom}$

Characteristic Curves

All test conditions are at 25°C The figures are identical for MCWI08-12D15

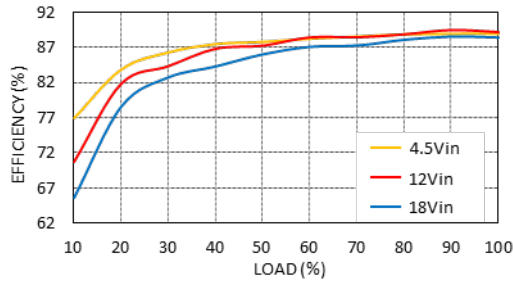

Efficiency Versus Output Current

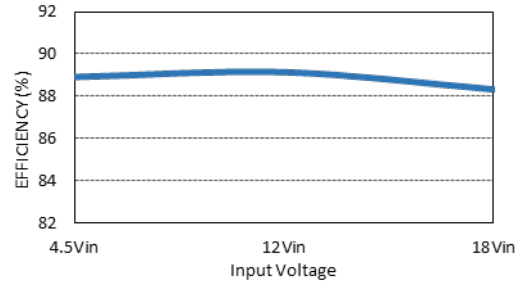

Efficiency Versus Input Voltage Full Load

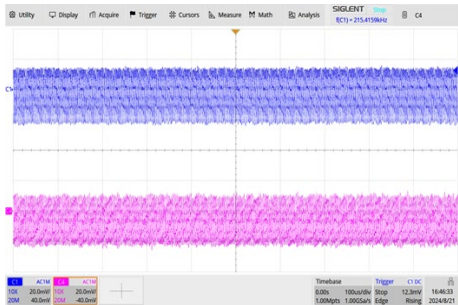

Typical Output Ripple and Noise
 $V_{in}=V_{in\ nom}$; Full Load

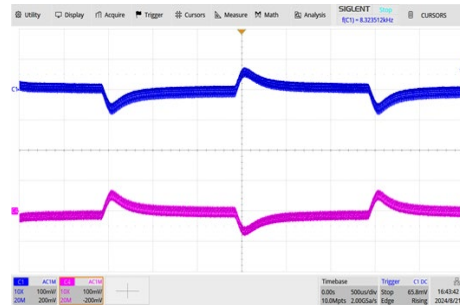

Transient Response to Dynamic Load Change
from 100% to 75% of Full Load ; $V_{in}=V_{in\ nom}$

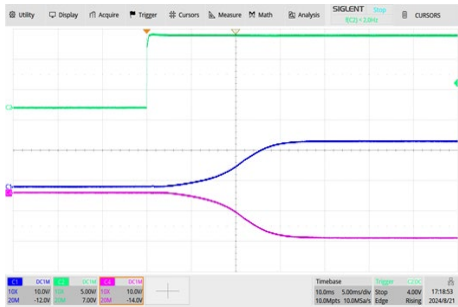

Typical Input Start-Up and Output Rise Characteristic
 $V_{in}=V_{in\ nom}$; Full Load

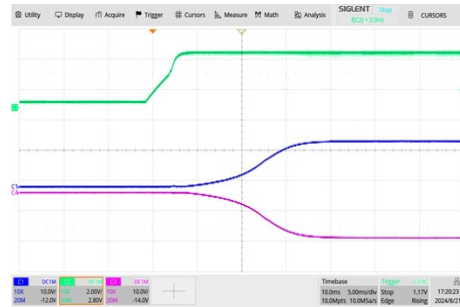

ON/OFF Voltage Start-Up and Output Rise Characteristic
 $V_{in}=V_{in\ nom}$; Full Load

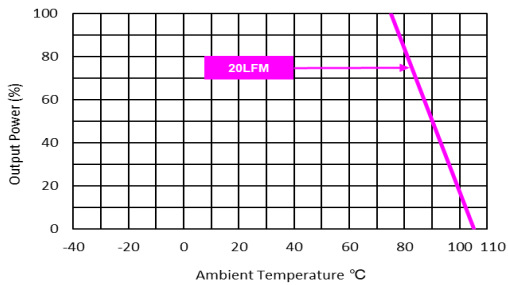

Derating Output Current Versus Ambient Temperature
 $V_{in}=V_{in\ nom}$

Characteristic Curves

All test conditions are at 25°C The figures are identical for MCWI08-24S05

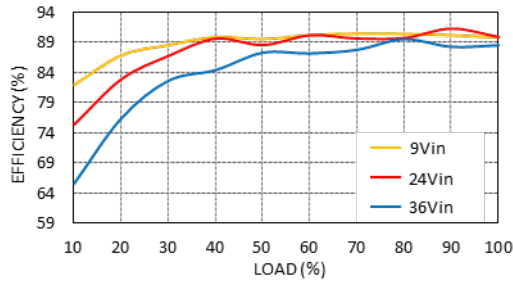

Efficiency Versus Output Current

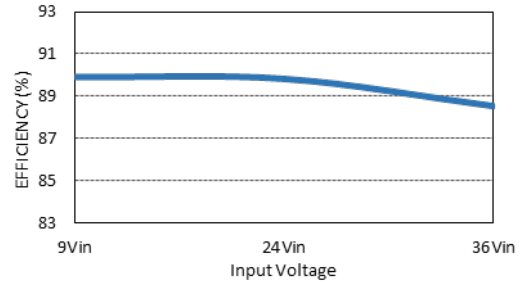

Efficiency Versus Input Voltage Full Load

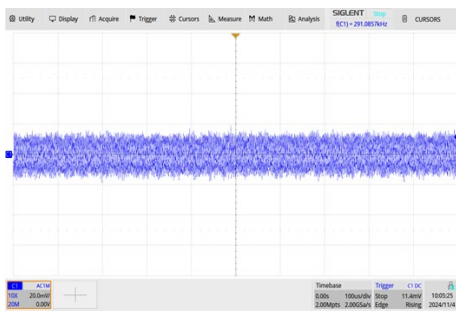

Typical Output Ripple and Noise
 $V_{in}=V_{in\ nom}$; Full Load

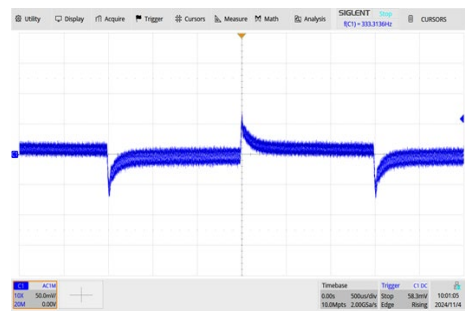

Transient Response to Dynamic Load Change
from 100% to 75% of Full Load; $V_{in}=V_{in\ nom}$

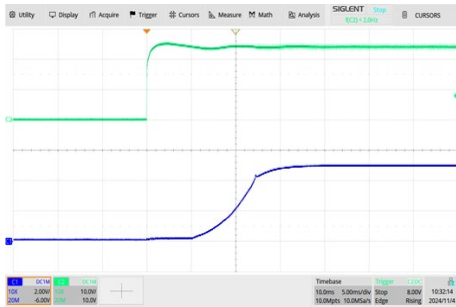

Typical Input Start-Up and Output Rise Characteristic
 $V_{in}=V_{in\ nom}$; Full Load

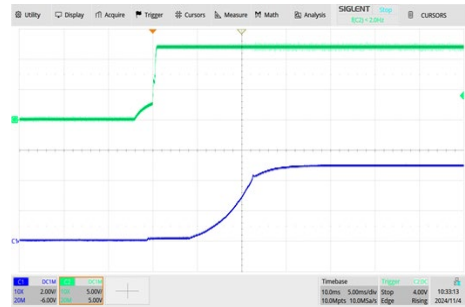

ON/OFF Voltage Start-Up and Output Rise Characteristic
 $V_{in}=V_{in\ nom}$; Full Load

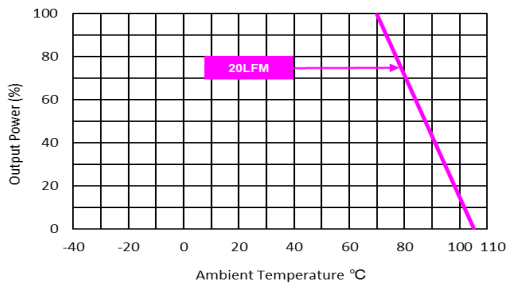

Derating Output Current Versus Ambient Temperature
 $V_{in}=V_{in\ nom}$

Characteristic Curves

All test conditions are at 25°C The figures are identical for MCWI08-24S12

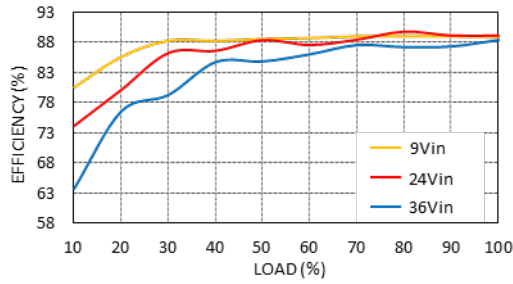

Efficiency Versus Output Current

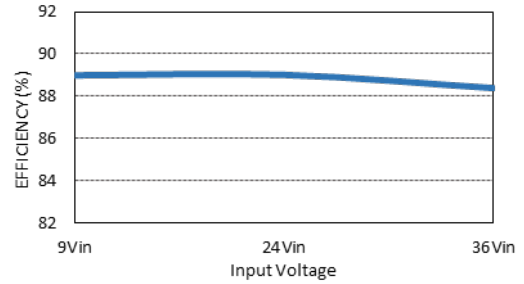

Efficiency Versus Input Voltage Full Load

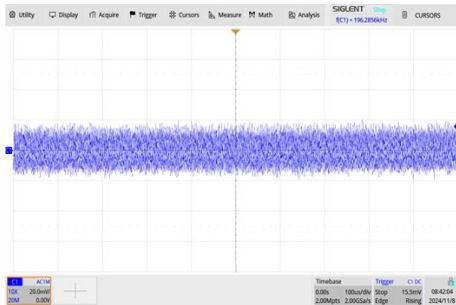

Typical Output Ripple and Noise
 $V_{in}=V_{in\ nom}$; Full Load

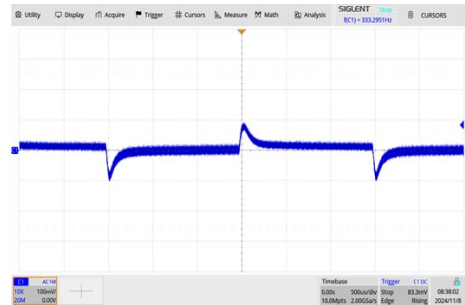

Transient Response to Dynamic Load Change
from 100% to 75% of Full Load; $V_{in}=V_{in\ nom}$

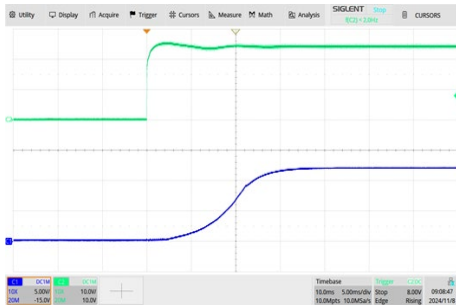

Typical Input Start-Up and Output Rise Characteristic
 $V_{in}=V_{in\ nom}$; Full Load

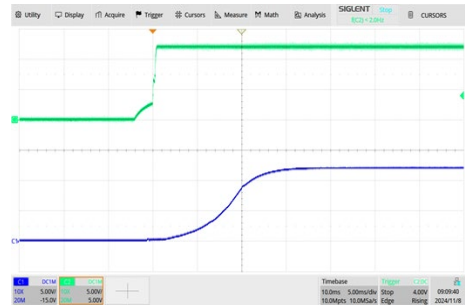

ON/OFF Voltage Start-Up and Output Rise Characteristic
 $V_{in}=V_{in\ nom}$; Full Load

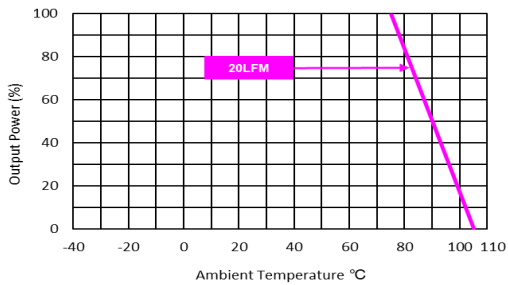

Derating Output Current Versus Ambient Temperature
 $V_{in}=V_{in\ nom}$

Characteristic Curves

All test conditions are at 25°C The figures are identical for MCWI08-24S15

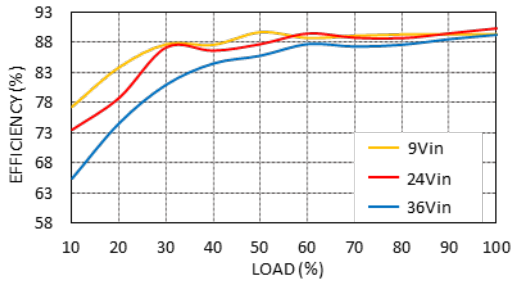

Efficiency Versus Output Current

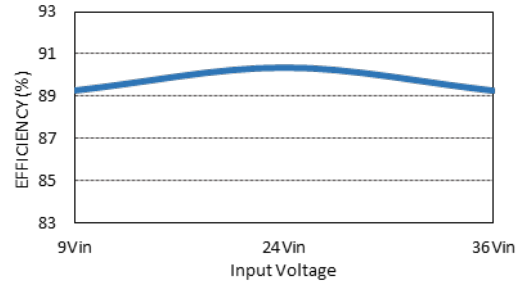

Efficiency Versus Input Voltage Full Load

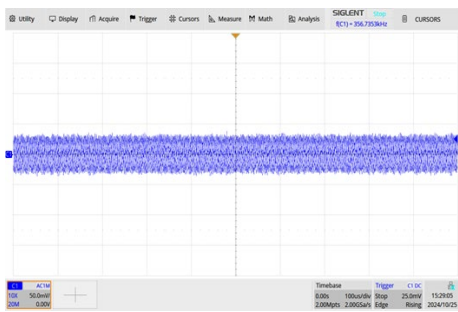

Typical Output Ripple and Noise
 $V_{in}=V_{in\ nom}$; Full Load

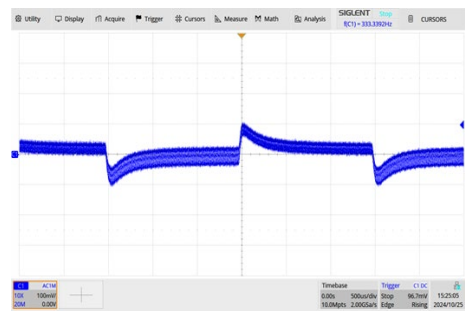

Transient Response to Dynamic Load Change
from 100% to 75% of Full Load; $V_{in}=V_{in\ nom}$

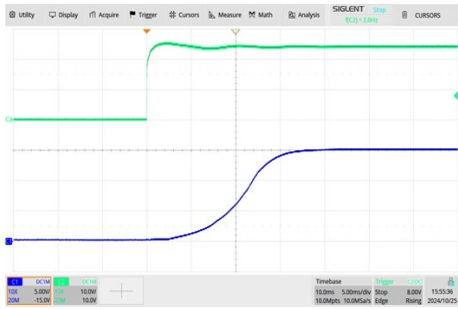

Typical Input Start-Up and Output Rise Characteristic
 $V_{in}=V_{in\ nom}$; Full Load

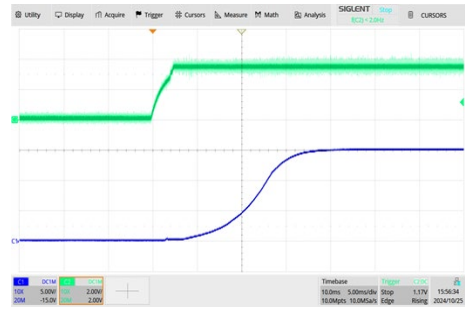

ON/OFF Voltage Start-Up and Output Rise Characteristic
 $V_{in}=V_{in\ nom}$; Full Load

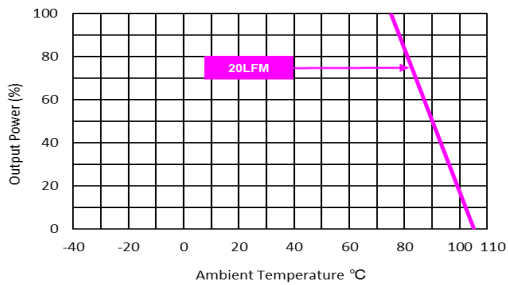

Derating Output Current Versus Ambient Temperature
 $V_{in}=V_{in\ nom}$

Characteristic Curves

All test conditions are at 25°C The figures are identical for MCWI08-24S24

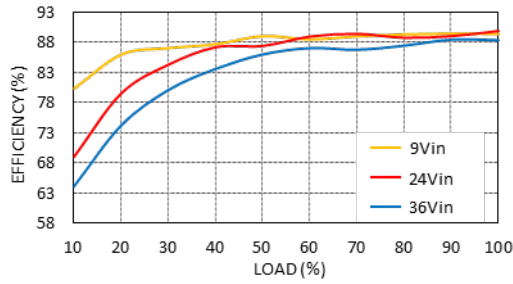

Efficiency Versus Output Current

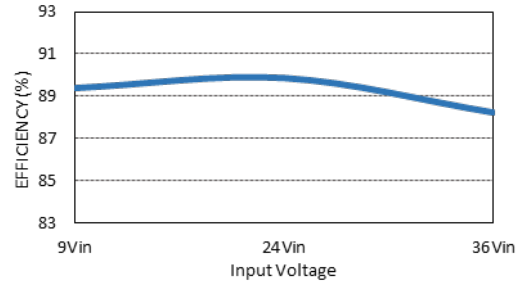

Efficiency Versus Input Voltage Full Load

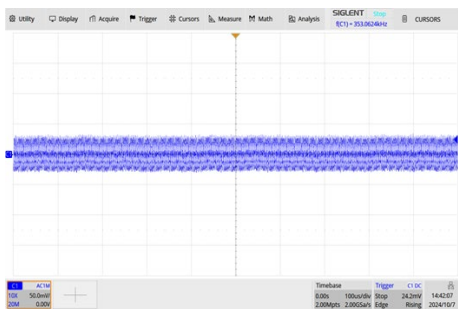

Typical Output Ripple and Noise
 $V_{in}=V_{in\ nom}$; Full Load



Transient Response to Dynamic Load Change
from 100% to 75% of Full Load ; $V_{in}=V_{in\ nom}$

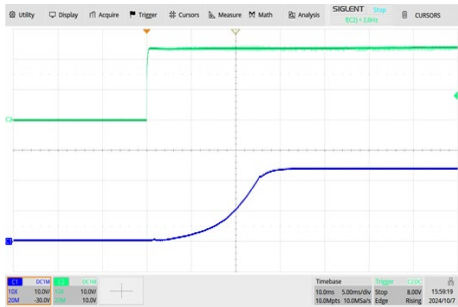

Typical Input Start-Up and Output Rise Characteristic
 $V_{in}=V_{in\ nom}$; Full Load

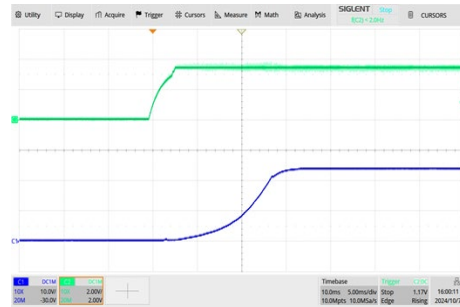

ON/OFF Voltage Start-Up and Output Rise Characteristic
 $V_{in}=V_{in\ nom}$; Full Load

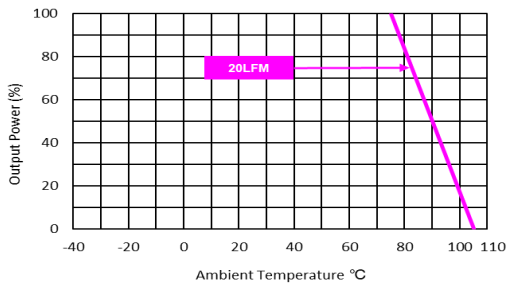

Derating Output Current Versus Ambient Temperature
 $V_{in}=V_{in\ nom}$

Characteristic Curves

All test conditions are at 25°C The figures are identical for MCWI08-24D12

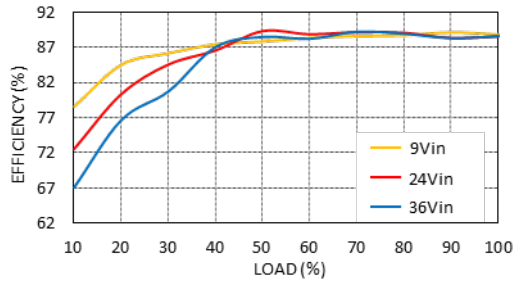

Efficiency Versus Output Current

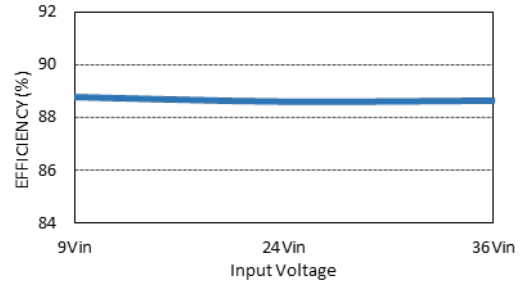

Efficiency Versus Input Voltage Full Load

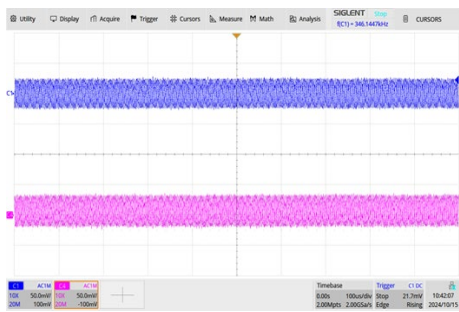

Typical Output Ripple and Noise
 $V_{in}=V_{in\ nom}$; Full Load

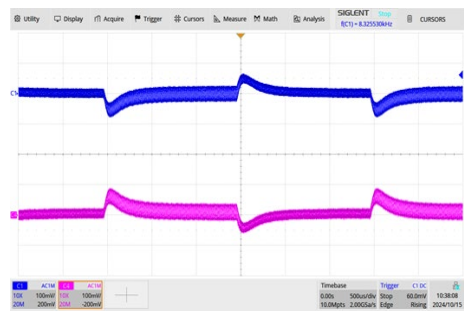

Transient Response to Dynamic Load Change
from 100% to 75% of Full Load; $V_{in}=V_{in\ nom}$

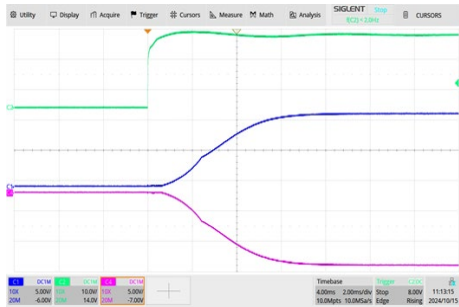

Typical Input Start-Up and Output Rise Characteristic
 $V_{in}=V_{in\ nom}$; Full Load

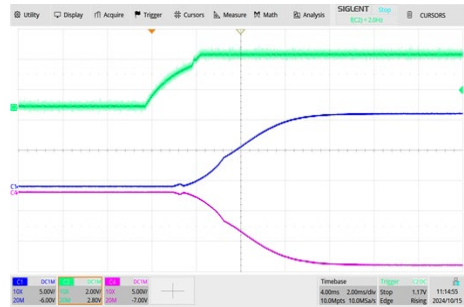

ON/OFF Voltage Start-Up and Output Rise Characteristic
 $V_{in}=V_{in\ nom}$; Full Load

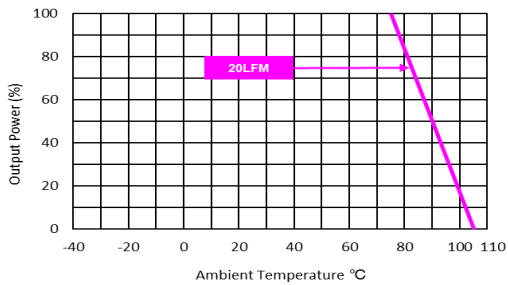

Derating Output Current Versus Ambient Temperature
 $V_{in}=V_{in\ nom}$

Characteristic Curves

All test conditions are at 25°C The figures are identical for MCWI08-24D15

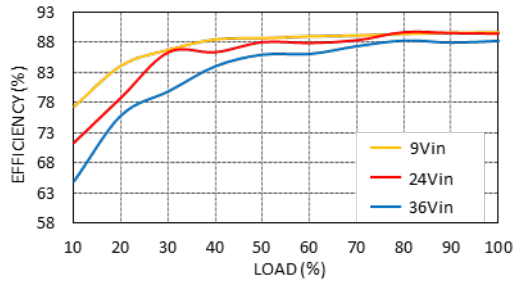

Efficiency Versus Output Current

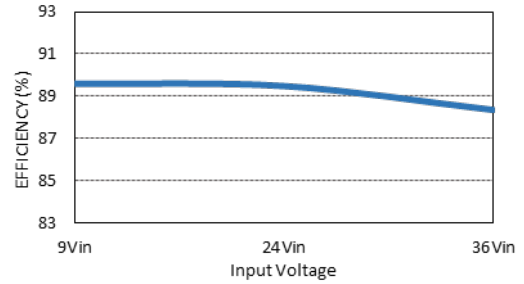

Efficiency Versus Input Voltage Full Load

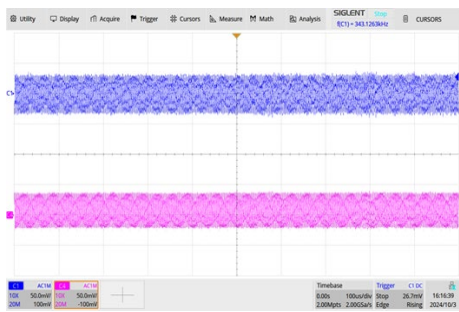

Typical Output Ripple and Noise
 $V_{in}=V_{in\ nom}$; Full Load

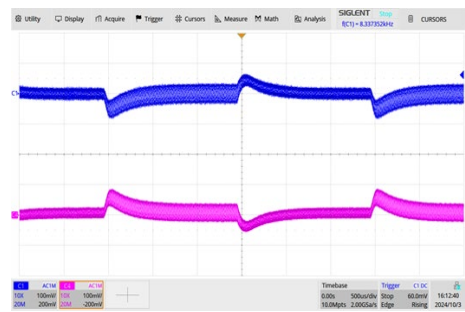

Transient Response to Dynamic Load Change
from 100% to 75% of Full Load ; $V_{in}=V_{in\ nom}$

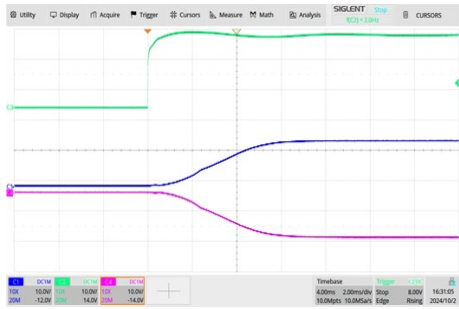

Typical Input Start-Up and Output Rise Characteristic
 $V_{in}=V_{in\ nom}$; Full Load

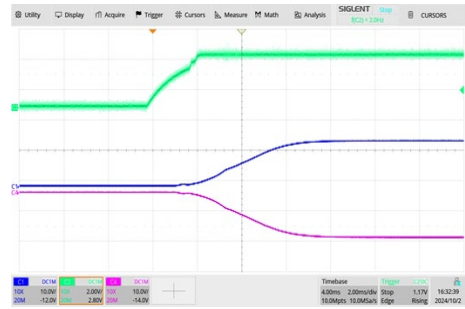

ON/OFF Voltage Start-Up and Output Rise Characteristic
 $V_{in}=V_{in\ nom}$; Full Load

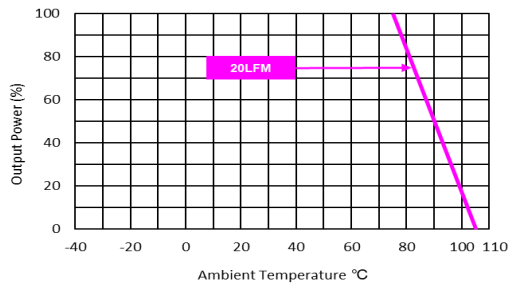

Derating Output Current Versus Ambient Temperature
 $V_{in}=V_{in\ nom}$

Characteristic Curves

All test conditions are at 25°C The figures are identical for MCWI08-48S05

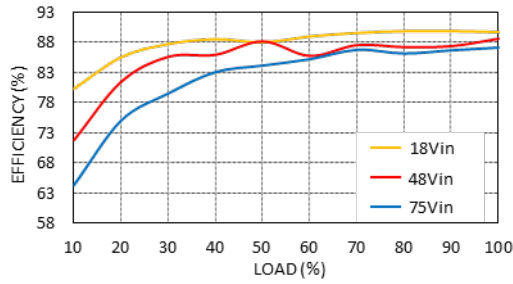

Efficiency Versus Output Current

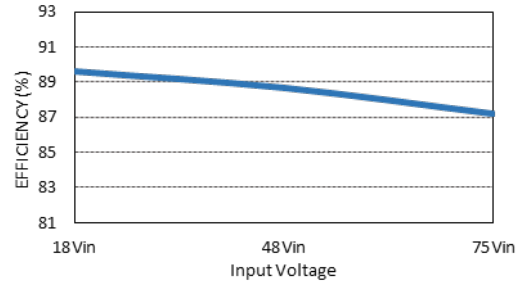

Efficiency Versus Input Voltage Full Load

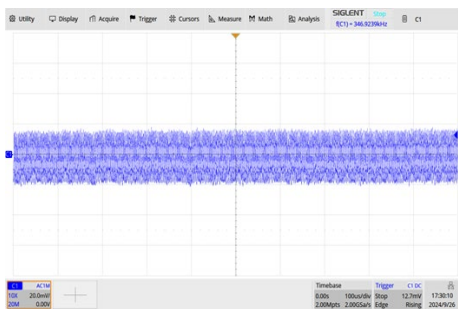

Typical Output Ripple and Noise
 $V_{in}=V_{in\ nom}$; Full Load

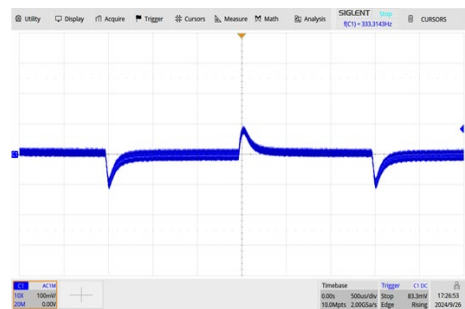

Transient Response to Dynamic Load Change
from 100% to 75% of Full Load; $V_{in}=V_{in\ nom}$

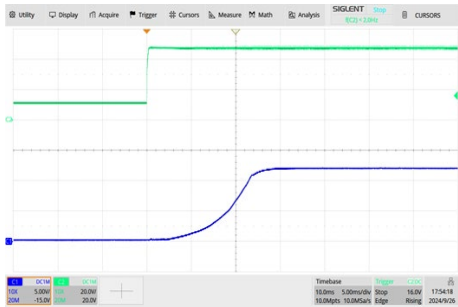

Typical Input Start-Up and Output Rise Characteristic
 $V_{in}=V_{in\ nom}$; Full Load

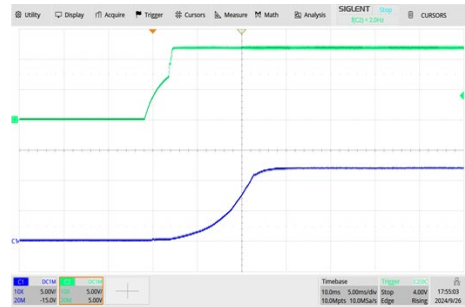

ON/OFF Voltage Start-Up and Output Rise Characteristic
 $V_{in}=V_{in\ nom}$; Full Load

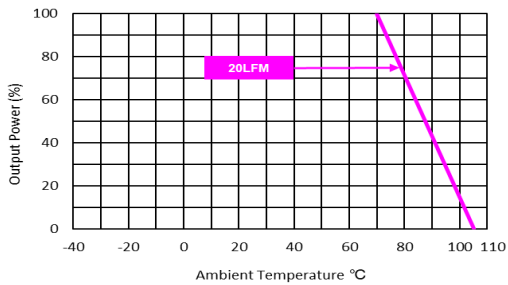

Derating Output Current Versus Ambient Temperature
 $V_{in}=V_{in\ nom}$

Characteristic Curves

All test conditions are at 25°C The figures are identical for MCWI08-48S12

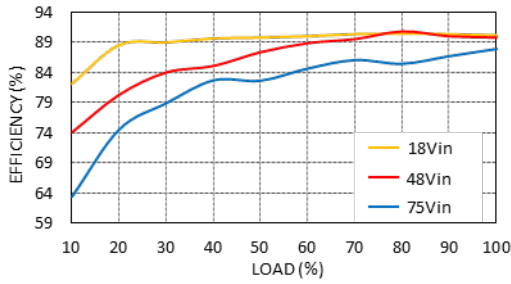

Efficiency Versus Output Current

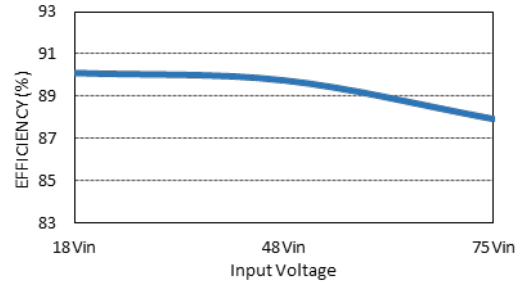

Efficiency Versus Input Voltage Full Load

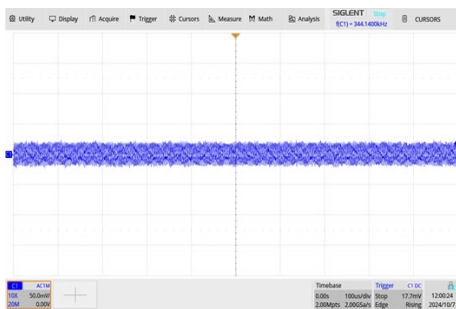

Typical Output Ripple and Noise
 $V_{in}=V_{in\ nom}$; Full Load

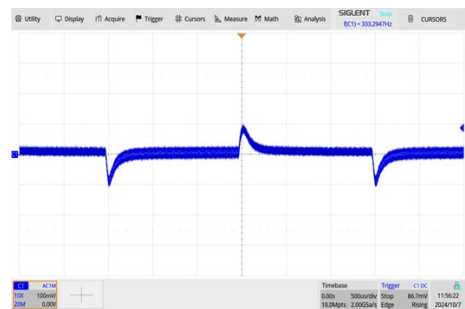

Transient Response to Dynamic Load Change
from 100% to 75% of Full Load; $V_{in}=V_{in\ nom}$

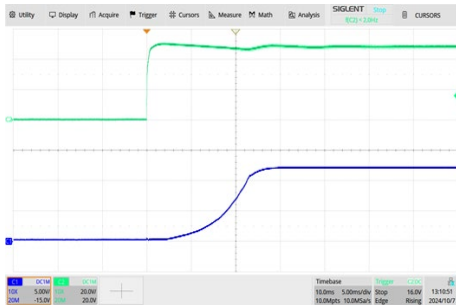

Typical Input Start-Up and Output Rise Characteristic
 $V_{in}=V_{in\ nom}$; Full Load

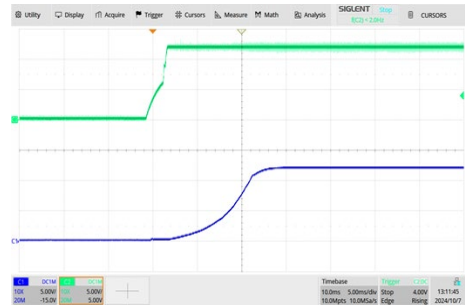

ON/OFF Voltage Start-Up and Output Rise Characteristic
 $V_{in}=V_{in\ nom}$; Full Load

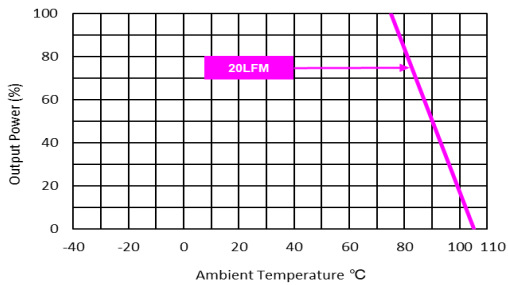

Derating Output Current Versus Ambient Temperature
 $V_{in}=V_{in\ nom}$

Characteristic Curves

All test conditions are at 25°C The figures are identical for MCWI08-48S15

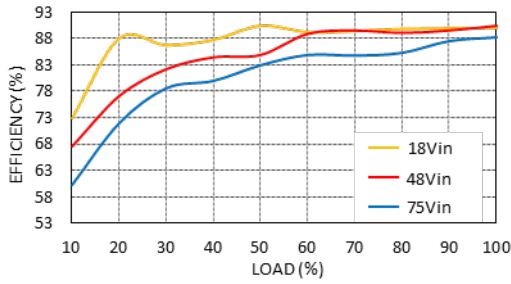

Efficiency Versus Output Current

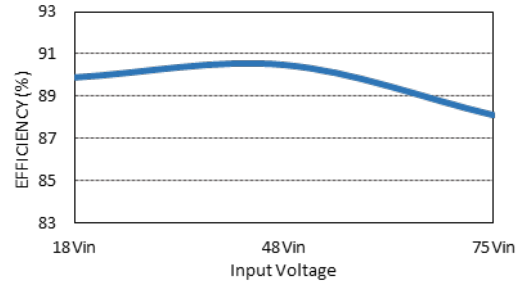

Efficiency Versus Input Voltage Full Load

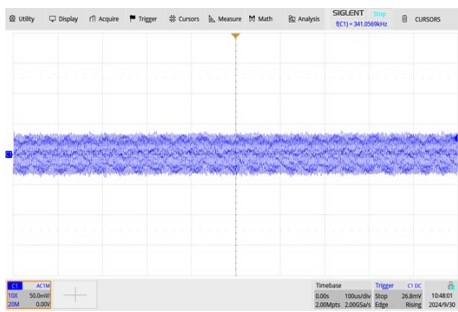

Typical Output Ripple and Noise
 $V_{in}=V_{in\ nom}$; Full Load

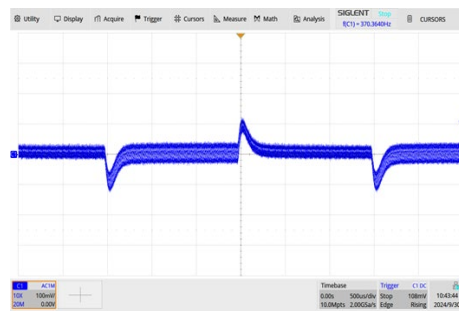

Transient Response to Dynamic Load Change
from 100% to 75% of Full Load; $V_{in}=V_{in\ nom}$

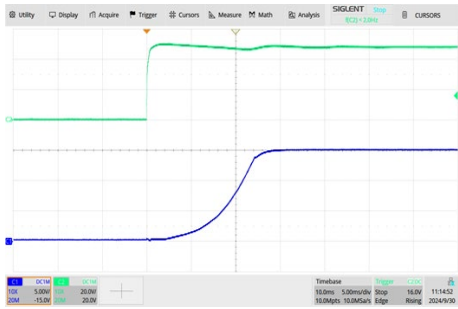

Typical Input Start-Up and Output Rise Characteristic
 $V_{in}=V_{in\ nom}$; Full Load

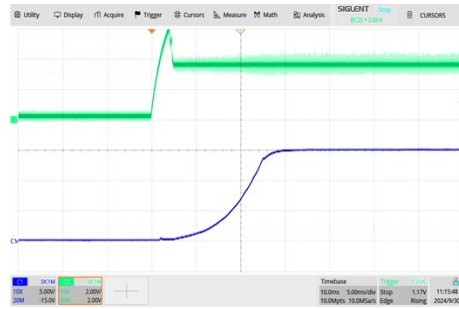

ON/OFF Voltage Start-Up and Output Rise Characteristic
 $V_{in}=V_{in\ nom}$; Full Load

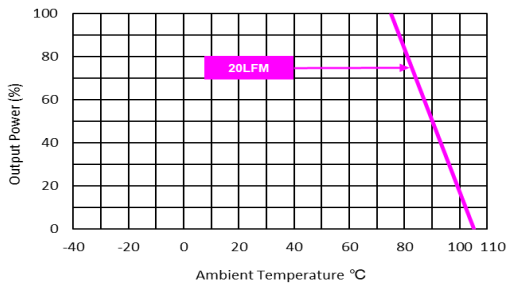

Derating Output Current Versus Ambient Temperature
 $V_{in}=V_{in\ nom}$

Characteristic Curves

All test conditions are at 25°C The figures are identical for MCWI08-48S24

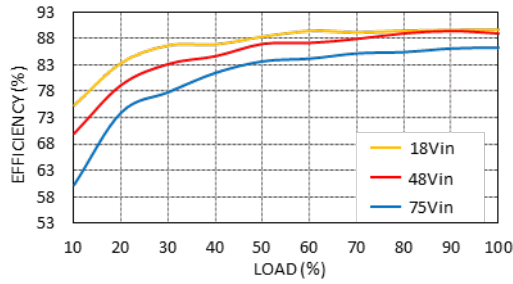

Efficiency Versus Output Current

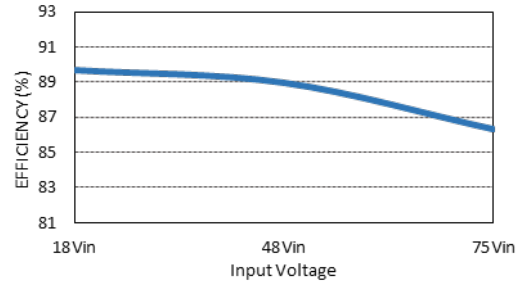

Efficiency Versus Input Voltage Full Load

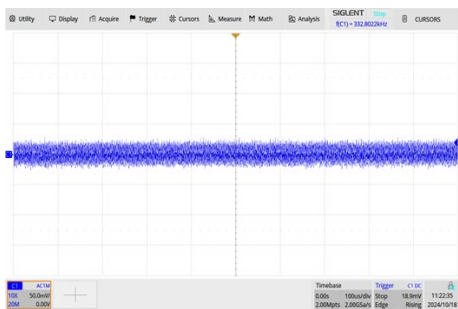

Typical Output Ripple and Noise
 $V_{in}=V_{in\ nom}$; Full Load

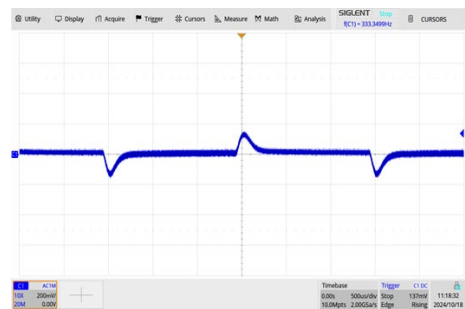

Transient Response to Dynamic Load Change
from 100% to 75% of Full Load; $V_{in}=V_{in\ nom}$

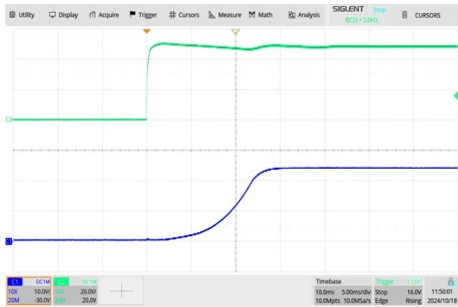

Typical Input Start-Up and Output Rise Characteristic
 $V_{in}=V_{in\ nom}$; Full Load

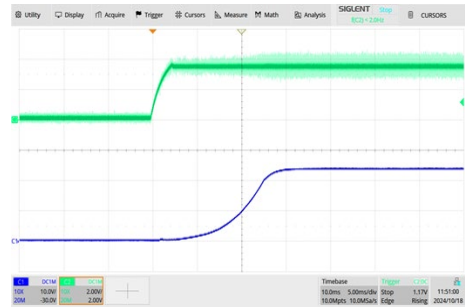

ON/OFF Voltage Start-Up and Output Rise Characteristic
 $V_{in}=V_{in\ nom}$; Full Load

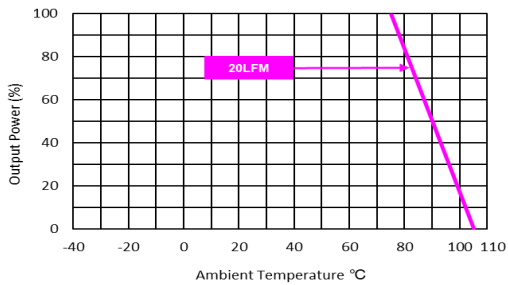

Derating Output Current Versus Ambient Temperature
 $V_{in}=V_{in\ nom}$

Characteristic Curves

All test conditions are at 25°C The figures are identical for MCWI08-48D12

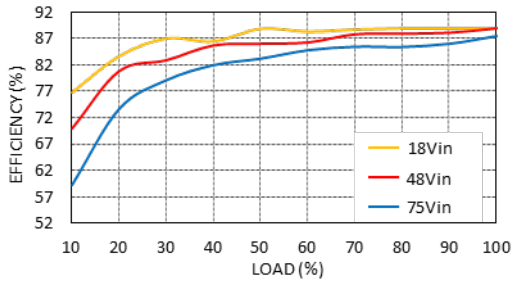

Efficiency Versus Output Current

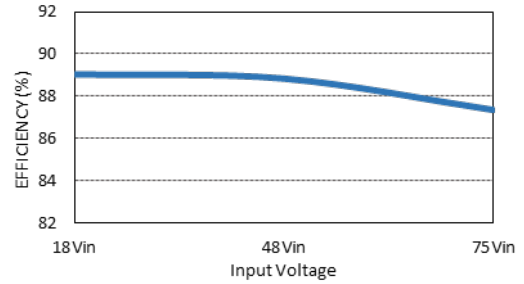

Efficiency Versus Input Voltage Full Load

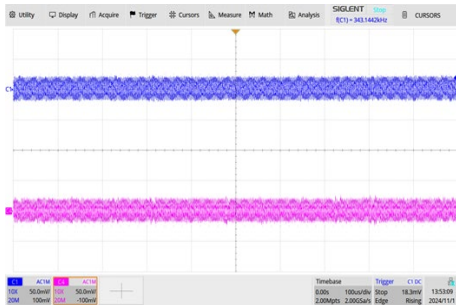

Typical Output Ripple and Noise
 $V_{in}=V_{in\ nom}$; Full Load

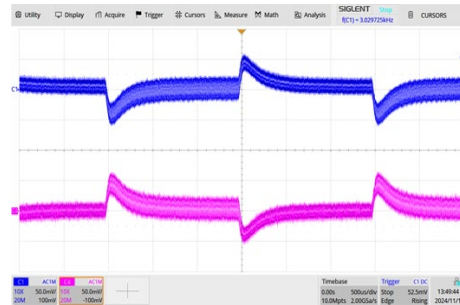

Transient Response to Dynamic Load Change
from 100% to 75% of Full Load; $V_{in}=V_{in\ nom}$

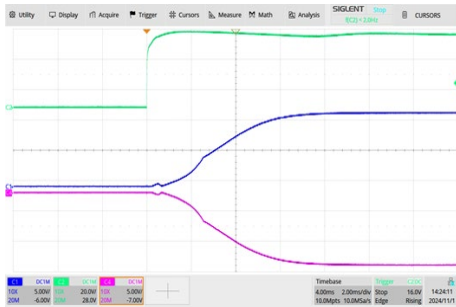

Typical Input Start-Up and Output Rise Characteristic
 $V_{in}=V_{in\ nom}$; Full Load

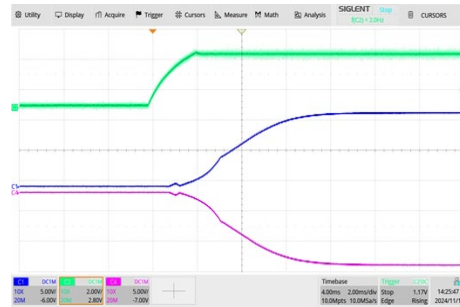

ON/OFF Voltage Start-Up and Output Rise Characteristic
 $V_{in}=V_{in\ nom}$; Full Load

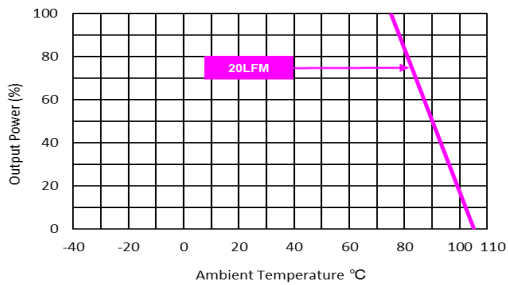

Derating Output Current Versus Ambient Temperature
 $V_{in}=V_{in\ nom}$

Characteristic Curves

All test conditions are at 25°C The figures are identical for MCWI08-48D15

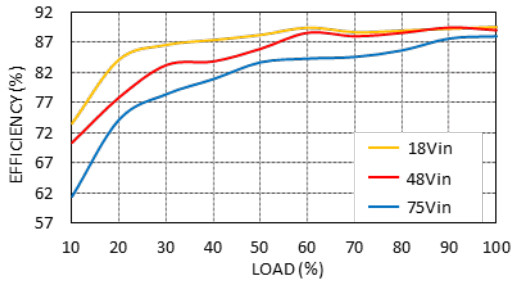

Efficiency Versus Output Current

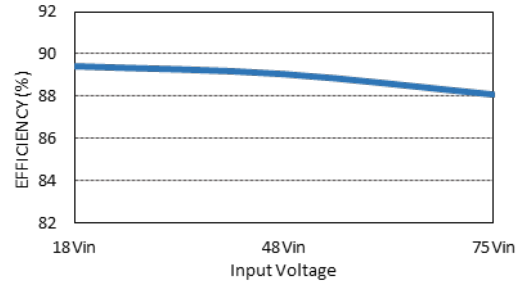

Efficiency Versus Input Voltage Full Load

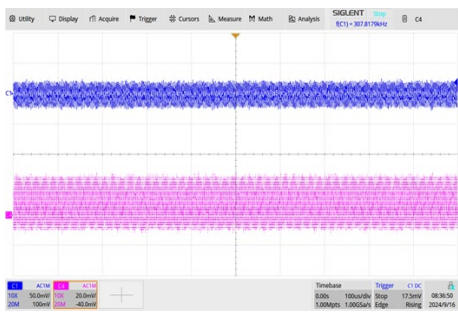

Typical Output Ripple and Noise
 $V_{in}=V_{in\ nom}$; Full Load

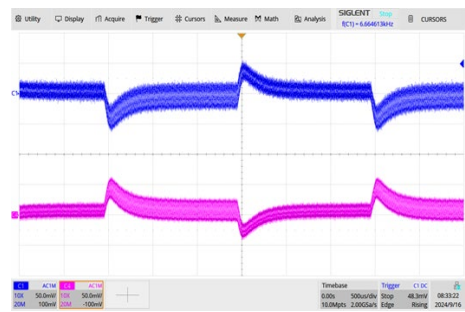

Transient Response to Dynamic Load Change
from 100% to 75% of Full Load ; $V_{in}=V_{in\ nom}$

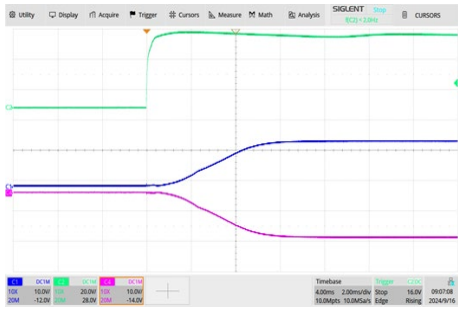

Typical Input Start-Up and Output Rise Characteristic
 $V_{in}=V_{in\ nom}$; Full Load

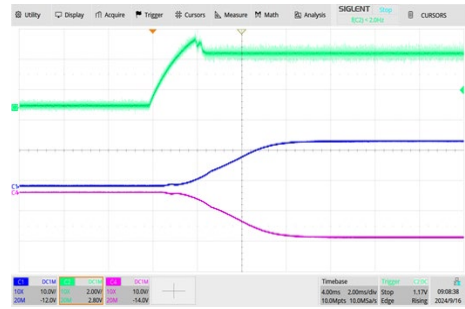

ON/OFF Voltage Start-Up and Output Rise Characteristic
 $V_{in}=V_{in\ nom}$; Full Load

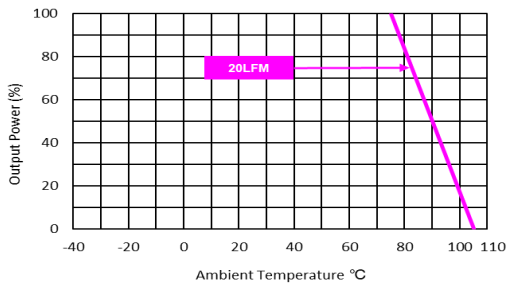

Derating Output Current Versus Ambient Temperature
 $V_{in}=V_{in\ nom}$

Package Specifications

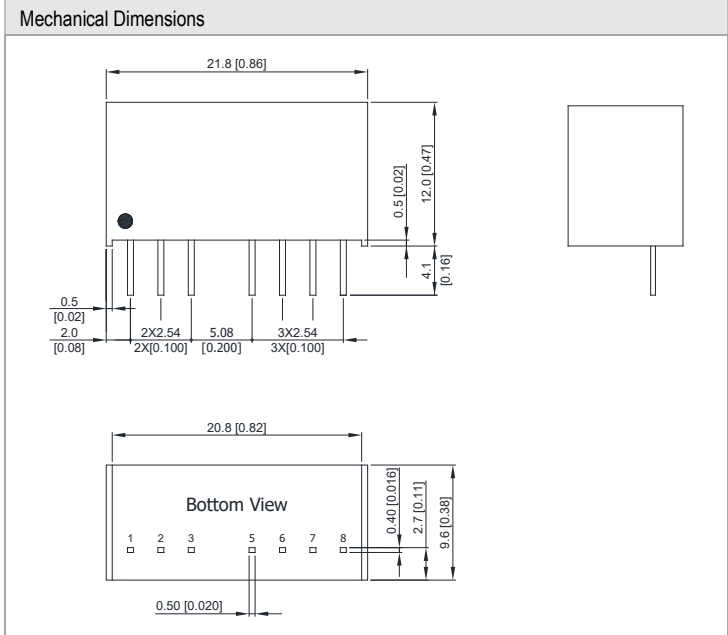

Pin Connections

Pin	Single Output	Dual Output
1	-Vin	-Vin
2	+Vin	+Vin
3	Remote On/Off	Remote On/Off
5	NC	NC
6	+Vout	+Vout
7	-Vout	Common
8	NC	-Vout

NC: No Connection

- ▶ All dimensions in mm (inches)
- ▶ Tolerance: X.X±0.5 (X.XX±0.02)
X.XX±0.25 (X.XXX±0.01)
- ▶ Pins ±0.1(±0.004)

Physical Characteristics

Case Size	: 21.8x9.6x12.0 mm (0.86x0.38x0.47 inches)
Case Material	: Plastic resin (flammability to UL 94V-0 rated)
Pin Material	: Phosphor Bronze
Weight	: 7g

Recommended Pad Layout

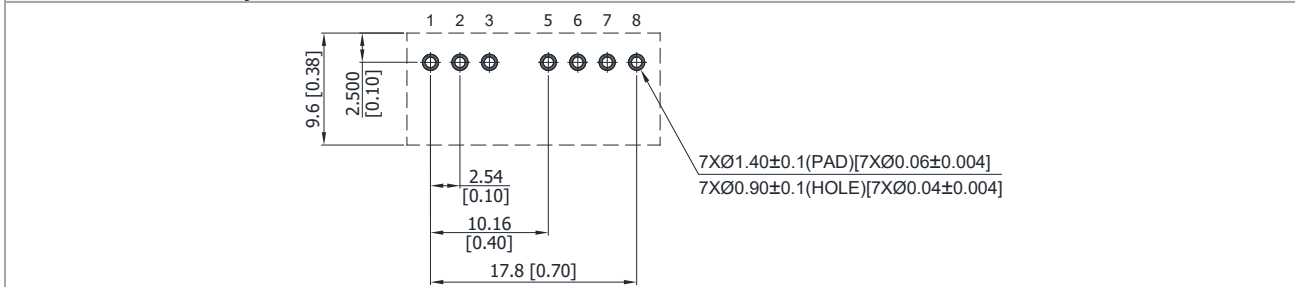

Test Setup

Peak-to-Peak Output Noise Measurement Test

Use a C_{out} $1\mu F$ ceramic capacitor. Scope measurement should be made by using a BNC socket, measurement bandwidth is 0-20 MHz. Position the load between 50 mm and 75 mm from the DC-DC Converter.

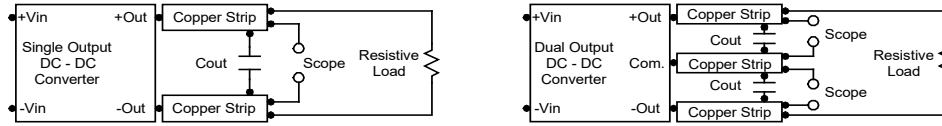

Technical Notes

Remote On/Off

Positive logic remote on/off turns the module on during a logic high voltage on the remote on/off pin, and off during a logic low. To turn the power module on and off, the user must supply a switch to control the voltage between the on/off terminal and the $-V_{in}$ terminal. The switch can be an open collector or equivalent. A logic high is 3.5V to 12V. A logic low is 0V to 1.2 V. The maximum sink current at on/off terminal during a logic low is $-500\mu A$. The maximum allowable leakage current of the switch at on/off terminal (0V to 1.2 V) is $500\mu A$.

Maximum Capacitive Load

The MCWI08 series has limitation of maximum connected capacitance at the output. The power module may be operated in current limiting mode during start-up, affecting the ramp-up and the startup time. The maximum capacitance can be found in the data sheet.

Overcurrent Protection

To provide protection in a fault (output overload) condition, the unit is equipped with internal current limiting circuitry and can endure current limiting for an unlimited duration. At the point of current-limit inception, the unit shifts from voltage control to current control. The unit operates normally once the output current is brought back into its specified range.

Input Source Impedance

The power module should be connected to a low ac-impedance input source. Highly inductive source impedances can affect the stability of the power module. In applications where power is supplied over long lines and output loading is high, it may be necessary to use a capacitor at the input to ensure startup. Capacitor mounted close to the power module helps ensure stability of the unit, it is commended to use a good quality low Equivalent Series Resistance (ESR < 1.0Ω at 100 kHz) capacitor of a $68\mu F$ for the 12V, 24V and 48V input devices.

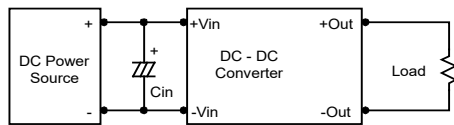

Output Ripple Reduction

A good quality low ESR capacitor placed as close as practicable across the load will give the best ripple and noise performance. To reduce output ripple, it is recommended to use $1\mu F$ capacitors at the output.

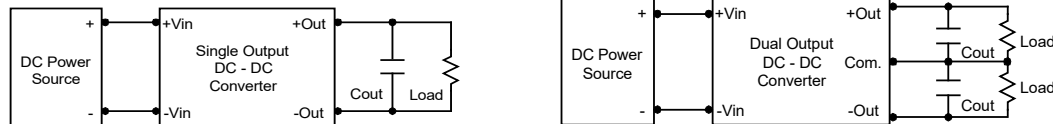

Thermal Considerations

Many conditions affect the thermal performance of the power module, such as orientation, airflow over the module and board spacing. To avoid exceeding the maximum temperature rating of the components inside the power module, the case temperature must be kept below $105^{\circ}C$. The derating curves are determined from measurements obtained in a test setup.

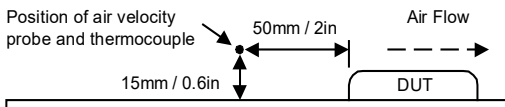

Remote ON/OFF Implementation

The positive logic remote ON/OFF control circuit is included. Turns the module ON during logic High on the ON/Off pin and turns OFF during logic Low. The ON/OFF input signal ($V_{on/off}$) that referenced to GND. If not using the remote on/off feature, please open circuit between on/off pin and $-V_{in}$ pin to turn the module on.

Remote ON/OFF implementation

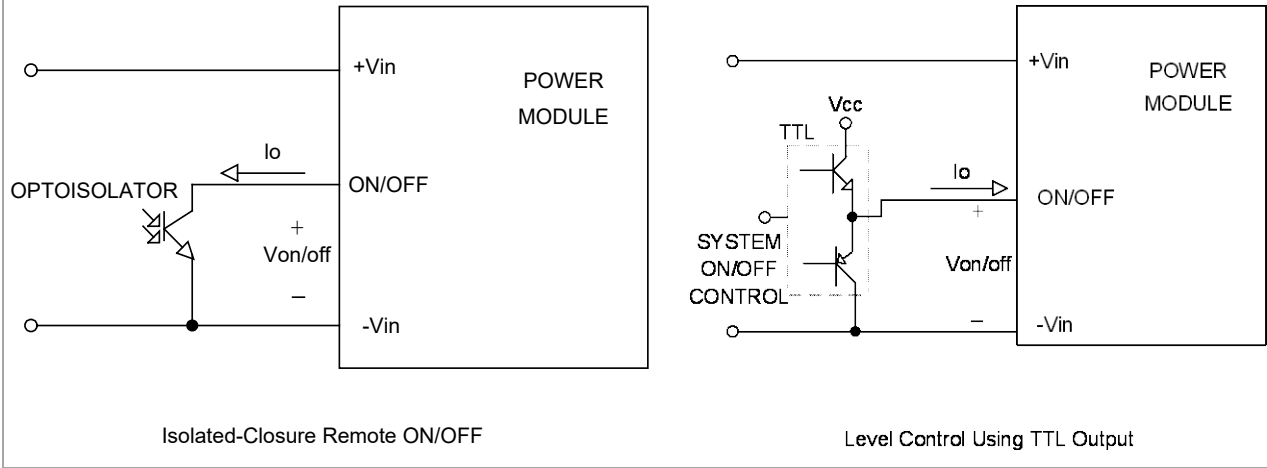

Packaging Information for Tube

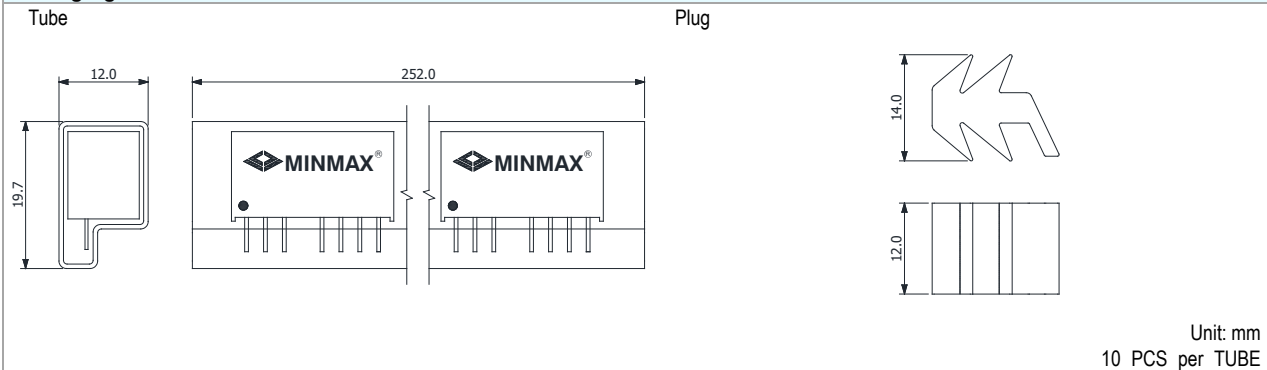

Wave Soldering Considerations

Lead free wave solder profile

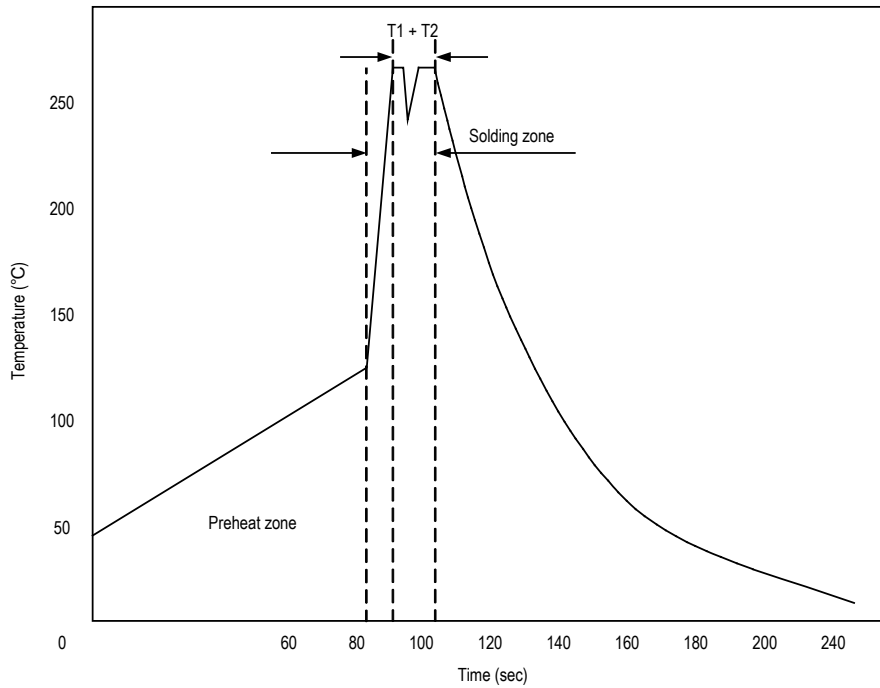

Zone	Reference Parameter
Preheat	Rise temp. speed : 3°C/sec max.
zone	Preheat temp. : 100~130°C
Actual	Peak temp. : 250~260°C
heating	Peak time(T1+T2) : 4~6 sec

Hand Welding Parameter

Reference Solder: Sn-Ag-Cu : Sn-Cu : Sn-Ag

Hand Welding: Soldering iron : Power 60W

Welding Time: 2~4 sec

Temp.: 380~400°C

Part Number Structure

M	C	WI	08	-	12	S	05
Package Type SIP-8	Ultra-wide 4:1 Input Voltage Range	Output Power 8 Watt	Input Voltage Range			Output Quantity	Output Voltage
			12: 4.5 ~ 18 VDC			S: Single	05: 5 VDC
			24: 9 ~ 36 VDC			D: Dual	12: 12 VDC
			48: 18 ~ 75 VDC				15: 15 VDC
							24: 24 VDC

MTBF and Reliability

The MTBF of MCWI08 series of DC-DC converters has been calculated using

MIL-HDBK 217F NOTICE2, Operating Temperature 25°C, Ground Benign.

Model	MTBF	Unit
MCWI08-12S05	2,124,310	Hours
MCWI08-12S12	2,820,709	
MCWI08-12S15	2,765,295	
MCWI08-12S24	2,704,081	
MCWI08-12D12	2,683,764	
MCWI08-12D15	2,606,003	
MCWI08-24S05	2,001,209	
MCWI08-24S12	2,786,564	
MCWI08-24S15	2,749,532	
MCWI08-24S24	2,713,830	
MCWI08-24D12	2,791,595	
MCWI08-24D15	2,754,173	
MCWI08-48S05	2,002,545	
MCWI08-48S12	2,779,060	
MCWI08-48S15	2,756,865	
MCWI08-48S24	2,719,118	
MCWI08-48D12	2,788,707	
MCWI08-48D15	2,760,803	