



MINMAX[®]

MDW10 Series

Electric Characteristic Note

MDW10 Series EC Note

DC-DC CONVERTER 10W, Regulated Output, DIP Package

Features

- ▶ Smallest Encapsulated 10W Converter
- ▶ Industrial Standard DIP-16 Package
- ▶ Wide 2:1 Input Voltage Range
- ▶ Fully Regulated Output Voltage
- ▶ I/O Isolation 1500 VDC
- ▶ Operating Ambient Temp. Range -40°C to +88°C
- ▶ Low No Load Power Consumption
- ▶ No Min. Load Requirement
- ▶ Under-voltage, Overload and Short Circuit Protection
- ▶ Shielded Metal Case with Insulated Baseplate
- ▶ Conducted EMI EN 55032 Class A Approved
- ▶ UL/cUL/IEC/EN 62368-1(60950-1) Safety Approval & CE Marking



Applications

- ▶ Distributed power architectures
- ▶ Workstations
- ▶ Computer equipment
- ▶ Communications equipment

Product Overview

The MDW10 series is a 10W isolated DC-DC power converter distinguished by its highly integrated design and the use of the industrial standard DIP-16 packaging. Compared to its predecessor, the MDW10 series has reduced its volume by 75%, decreased weight by 79%, and achieved a power density of 63W/in³. Since its launch, this series has garnered widespread attention and procurement from industrial, medical, transportation, and power equipment manufacturers.

The MDW10 series offers a diverse range of options, including input voltage ranges of 9-18VDC, 18-36VDC, and 36-75VDC. It provides 24 different output voltage models, such as 3.3V, 5V, 5.1V, 12V, 15V, 24V, ±12V, and ±15VDC, all of which deliver stable output voltages.

MINMAX's primary advantage lies in its focus on minimizing the size of power modules while maintaining excellent electrical performance. The MDW10 series boasts an 88% high conversion efficiency and outstanding instantaneous load capability. Even under drastic external condition changes, it maintains highly stable output voltage, power loss, and heat performance. Other features include input under-voltage protection, output overload protection, output short-circuit protection, extremely low no-load power consumption, and no minimum load requirements. All models in the MDW10 series are CB certified, EMI conducted Class A certified, and have safety certifications such as UL/cUL/IEC/EN 62368-1.

The MDW10 series finds extensive applications in areas such as semiconductor processing equipment, power supplies, intelligent inspection robots, charging stations, motion controllers, power regulators, energy storage systems, quickly becoming one of MINMAX's standout product series with exceptionally high repeat purchase rates and customer satisfaction.

Table of contents

Model Selection Guide	P2	Recommended Pad Layout for Single & Dual Output Converter	P29
Input Specifications.....	P2	Test Setup.....	P30
Output Specifications.....	P3	Technical Notes	P30
General Specifications.....	P3	Packaging Information for Tube	P31
EMC Specifications.....	P3	Wave Soldering Considerations	P31
Environmental Specifications	P4	Hand Welding Parameter	P31
Characteristic Curves	P5	Part Number Structure	P32
Package Specifications	P29	MTBF and Reliability	P32

Model Selection Guide

Model Number	Input Voltage (Range)	Output Voltage	Output Current	Input Current		Max. capacitive Load	Efficiency (typ.)
				@Max. Load	@No Load		
	VDC	VDC	mA	mA(typ.)	mA(typ.)	μF	%
MDW10-12S033	12 (9 ~ 18)	3.3	2700	940	20	2600	79
MDW10-12S05		5	2000	1016		1300	82
MDW10-12S051		5.1	2000	1037		1300	82
MDW10-12S12		12	833	969		560	86
MDW10-12S15		15	666	957		560	87
MDW10-12S24		24	416	956		200	87
MDW10-12D12		±12	±416	967		390#	86
MDW10-12D15		±15	±333	968		200#	86
MDW10-24S033	24 (18 ~ 36)	3.3	2700	464	10	2600	80
MDW10-24S05		5	2000	502		1300	83
MDW10-24S051		5.1	2000	512		1300	83
MDW10-24S12		12	833	479		560	87
MDW10-24S15		15	666	473		560	88
MDW10-24S24		24	416	473		200	88
MDW10-24D12		±12	±416	478		390#	87
MDW10-24D15		±15	±333	478		200#	87
MDW10-48S033	48 (36 ~ 75)	3.3	2700	232	8	2600	80
MDW10-48S05		5	2000	251		1300	83
MDW10-48S051		5.1	2000	256		1300	83
MDW10-48S12		12	833	239		560	87
MDW10-48S15		15	666	237		560	88
MDW10-48S24		24	416	236		200	88
MDW10-48D12		±12	±416	239		390#	87
MDW10-48D15		±15	±333	239		200#	87

For each output

Input Specifications

Parameter	Conditions / Model	Min.	Typ.	Max.	Unit
Input Surge Voltage (1 sec. max.)	12V Input Models	-0.7	---	25	VDC
	24V Input Models	-0.7	---	50	
	48V Input Models	-0.7	---	100	
Start-Up Threshold Voltage	12V Input Models	---	---	9	
	24V Input Models	---	---	18	
	48V Input Models	---	---	36	
Under Voltage Shutdown	12V Input Models	---	8	---	
	24V Input Models	---	16	---	
	48V Input Models	---	34	---	
Start Up Time (Power On)	Nominal Vin and Constant Resistive Load	---	30	---	ms
Input Filter	All Models	Internal Pi Type			

Output Specifications						
Parameter	Conditions / Model		Min.	Typ.	Max.	Unit
Output Voltage Setting Accuracy			---	---	±1.0	%Vnom.
Output Voltage Balance	Dual Output, Balanced Loads		---	±1.0	±2.0	%
Line Regulation	Vin=Min. to Max. @Full Load		---	±0.2	±0.8	%
Load Regulation	Io=0% to 100%		---	---	±1.0	%
Load Cross Regulation (Dual Output Models)	Asymmetrical Load 25/100% Full Load		---	---	±5.0	%
Minimum Load	No minimum Load Requirement					
Ripple & Noise	0-20 MHz Bandwidth	3.3, 5V, 5.1V Output	---	60	---	mV P-P
		Other Output	---	80	---	mV P-P
Transient Recovery Time	25% Load Step Change		---	---	500	µsec
Transient Response Deviation			---	±3	±5	%
Temperature Coefficient			---	±0.01	±0.02	%/°C
Over Load Protection	Hiccup		---	160	---	%
Short Circuit Protection	Continuous, Automatic Recovery (Hiccup Mode 0.3Hz typ.)					

General Specifications						
Parameter	Conditions	Min.	Typ.	Max.	Unit	
I/O Isolation Voltage	60 Seconds	1500	---	---	VDC	
	1 Second	1800	---	---	VDC	
Isolation Voltage Input/Output to case		1000	---	---	VDC	
I/O Isolation Resistance	500 VDC	1000	---	---	MΩ	
I/O Isolation Capacitance	100kHz, 1V	---	---	1500	pF	
Switching Frequency		---	420	---	kHz	
MTBF (calculated)	MIL-HDBK-217F@25°C, Ground Benign	1,814,779	---	---	Hours	
Safety Approvals	UL/cUL 60950-1 recognition (UL certificate), IEC/EN 60950-1 (CB-report)					
	UL/cUL 62368-1 recognition (UL certificate), IEC/EN 62368-1 (CB-report)					

EMC Specifications						
Parameter	Standards & Level				Performance	
EMI ₍₅₎	Conduction	EN 55032	Without external components		Class A	
	Radiation		With external components			
EMS ₍₅₎	EN 55035					
	ESD	Direct discharge		Indirect discharge HCP & VCP		A
		EN 61000-4-2 Air ± 8kV, Contact ± 6kV		Contact ± 6kV		
	Radiated immunity	EN 61000-4-3 20V/m				A
	Fast transient	EN 61000-4-4 ±2kV				A
	Surge	EN 61000-4-5 ±2kV				A
	Conducted immunity	EN 61000-4-6 10Vrms				A
PFMF	EN 61000-4-8 100A/m, 1000A/m (1 sec.)				A	

Environmental Specifications				
Parameter	Conditions / Model	Min.	Max.	Unit
Operating Ambient Temperature Range Nominal Vin, Load 100% Inom. (for Power Derating see relative Derating Curves)	MDW10-12S15, MDW10-12S24, MDW10-24S12, MDW10-24S15 MDW10-24S24, MDW10-24D12, MDW10-24D15, MDW10-48S12 MDW10-48S15, MDW10-48S24, MDW10-48D12, MDW10-48D15	-40	+72	°C
	MDW10-12S12, MDW10-12D12, MDW10-12D15		+65	
	MDW10-12S05, MDW10-12S051, MDW10-24S033, MDW10-24S05 MDW10-24S051, MDW10-48S033, MDW10-48S05, MDW10-48S051		+54	
	MDW10-12S033		+47	
	Case Temperature		---	
Storage Temperature Range		-50	+125	°C
Humidity (non condensing)		---	95	% rel. H
Lead Temperature (1.5mm from case for 10 sec.)		---	260	°C

Notes

- 1 Specifications typical at Ta=+25°C, resistive load, nominal input voltage and rated output current unless otherwise noted.
- 2 Transient recovery time is measured to within 1% error band for a step change in output load of 75% to 100%.
- 3 We recommend to protect the converter by a slow blow fuse in the input supply line.
- 4 Other input and output voltage may be available, please contact MINMAX.
- 5 The external components might be required to meet EMI/EMS standard for some of test items. Please contact MINMAX for the solution in detail.
- 6 Specifications are subject to change without notice.
- 7 The repeated high voltage isolation testing of the converter can degrade isolation capability, to a lesser or greater degree depending on materials, construction, environment and reflow solder process. Any material is susceptible to eventual chemical degradation when subject to very high applied voltages thus implying that the number of tests should be strictly limited. We therefore strongly advise against repeated high voltage isolation testing, but if it is absolutely required, that the voltage be reduced by 20% from specified test voltage. Furthermore, the high voltage isolation capability after reflow solder process should be evaluated as it is applied on system.

Characteristic Curves

All test conditions are at 25°C The figures are identical for MDW10-12S033

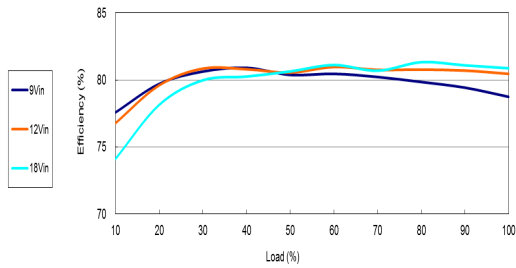

Efficiency Versus Output Current

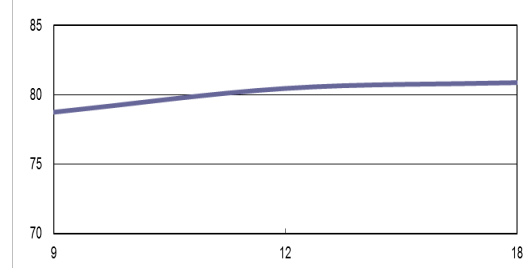

Efficiency Versus Input Voltage Full Load

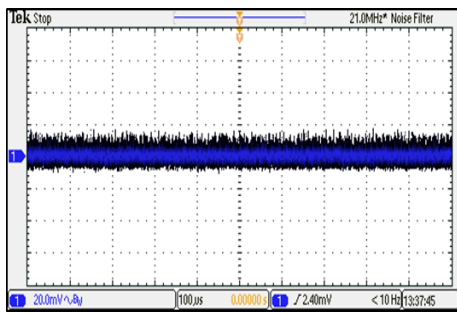

Typical Output Ripple and Noise
 $V_{in}=V_{in\ nom}$; Full Load

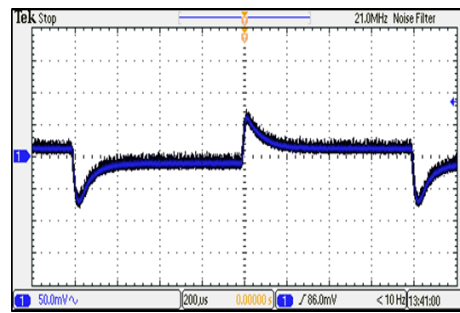

Transient Response to Dynamic Load Change
from 100% to 75% of Full Load ; $V_{in}=V_{in\ nom}$

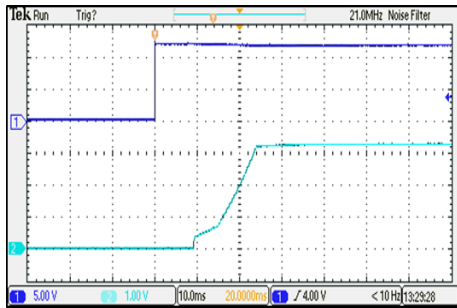

Typical Input Start-Up and Output Rise Characteristic
 $V_{in}=V_{in\ nom}$; Full Load

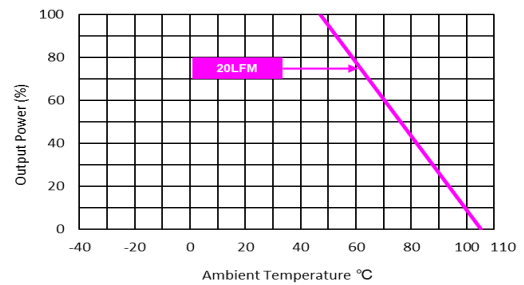

Derating Output Current Versus Ambient Temperature and Airflow
 $V_{in}=V_{in\ nom}$

Characteristic Curves

All test conditions are at 25°C The figures are identical for MDW10-12S05

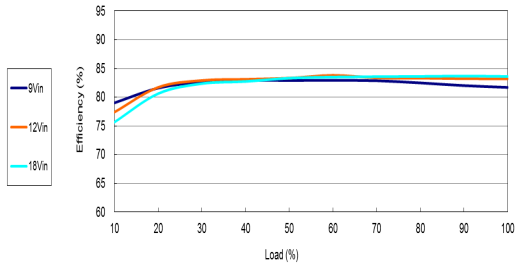

Efficiency Versus Output Current

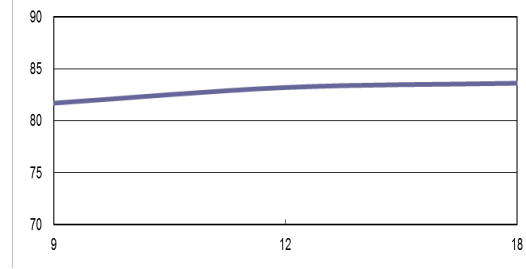

Efficiency Versus Input Voltage Full Load

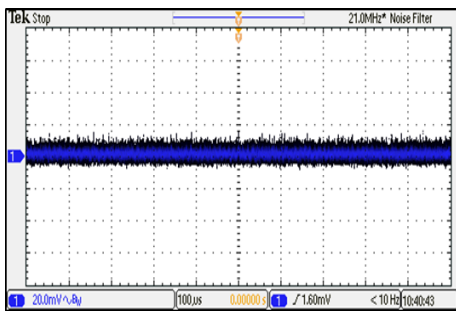

Typical Output Ripple and Noise
 $V_{in}=V_{in\ nom}$; Full Load

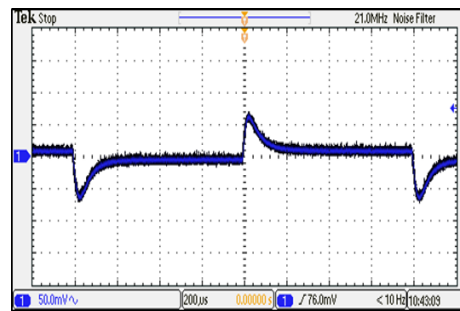

Transient Response to Dynamic Load Change
from 100% to 75% of Full Load ; $V_{in}=V_{in\ nom}$

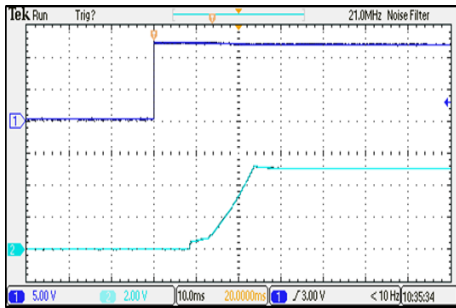

Typical Input Start-Up and Output Rise Characteristic
 $V_{in}=V_{in\ nom}$; Full Load

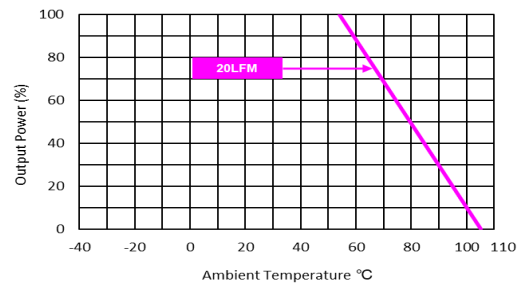

Derating Output Current Versus Ambient Temperature and Airflow
 $V_{in}=V_{in\ nom}$

Characteristic Curves

All test conditions are at 25°C The figures are identical for MDW10-12S051

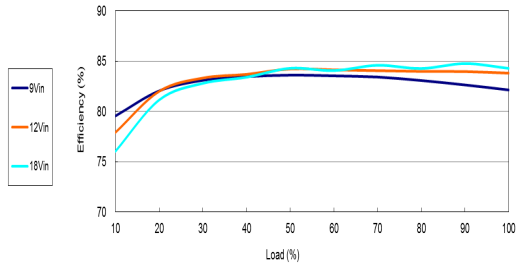

Efficiency Versus Output Current

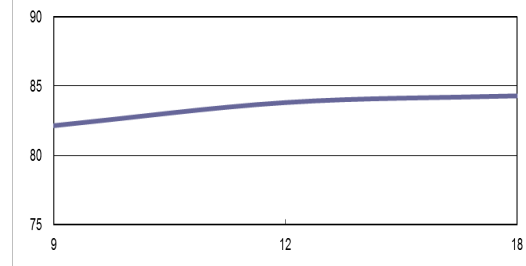

Efficiency Versus Input Voltage Full Load

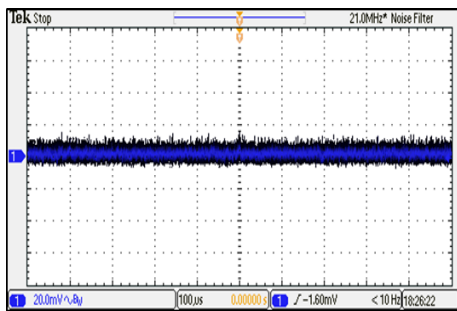

Typical Output Ripple and Noise
 $V_{in}=V_{in\ nom}$; Full Load

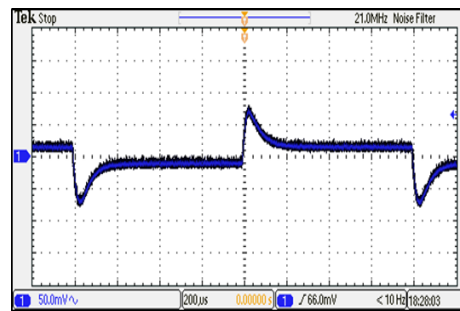

Transient Response to Dynamic Load Change
from 100% to 75% of Full Load ; $V_{in}=V_{in\ nom}$

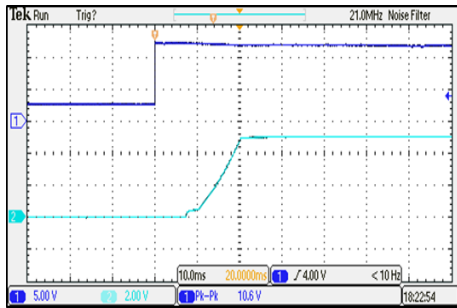

Typical Input Start-Up and Output Rise Characteristic
 $V_{in}=V_{in\ nom}$; Full Load

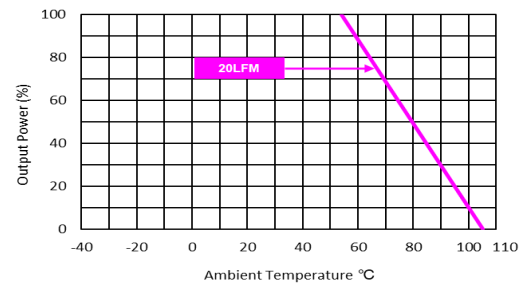

Derating Output Current Versus Ambient Temperature and Airflow
 $V_{in}=V_{in\ nom}$

Characteristic Curves

All test conditions are at 25°C The figures are identical for MDW10-12S12

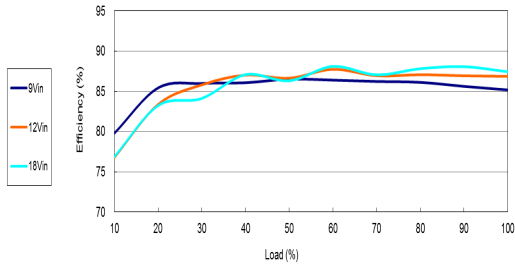

Efficiency Versus Output Current

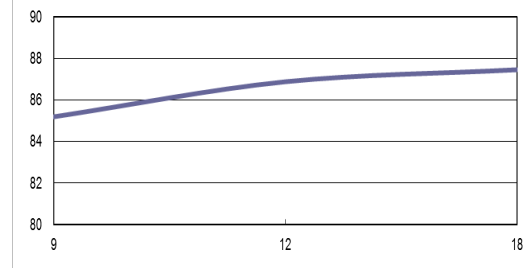

Efficiency Versus Input Voltage Full Load

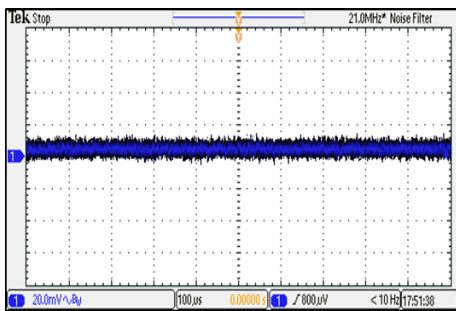

Typical Output Ripple and Noise
 $V_{in}=V_{in\ nom}$; Full Load

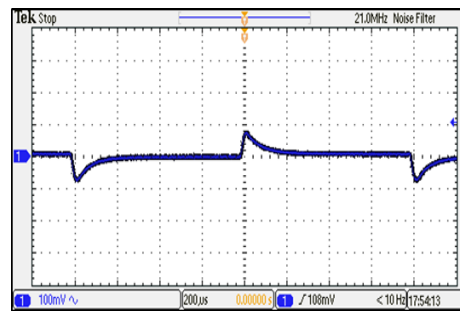

Transient Response to Dynamic Load Change
from 100% to 75% of Full Load ; $V_{in}=V_{in\ nom}$

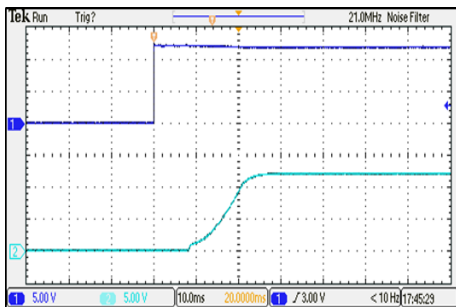

Typical Input Start-Up and Output Rise Characteristic
 $V_{in}=V_{in\ nom}$; Full Load

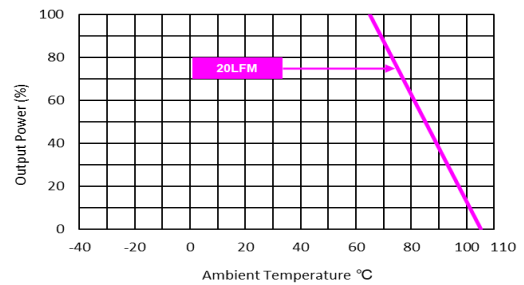

Derating Output Current Versus Ambient Temperature and Airflow
 $V_{in}=V_{in\ nom}$

Characteristic Curves

All test conditions are at 25°C The figures are identical for MDW10-12S15

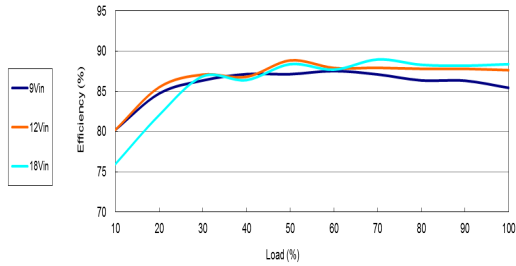

Efficiency Versus Output Current

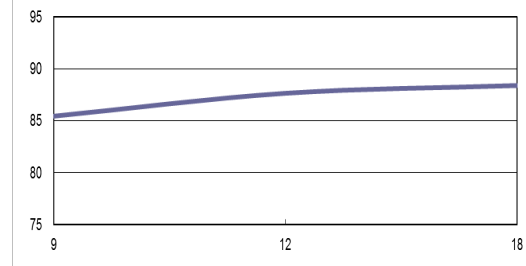

Efficiency Versus Input Voltage Full Load

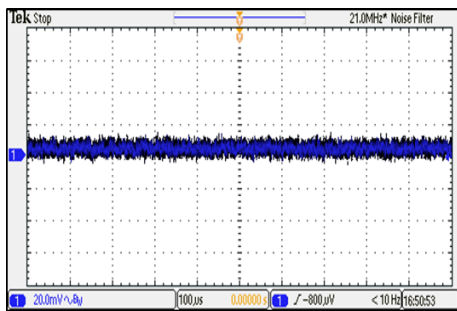

Typical Output Ripple and Noise
 $V_{in}=V_{in\ nom}$; Full Load

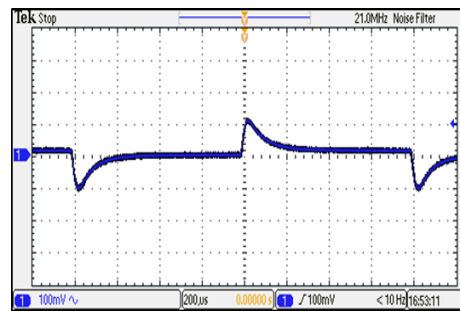

Transient Response to Dynamic Load Change
from 100% to 75% of Full Load ; $V_{in}=V_{in\ nom}$

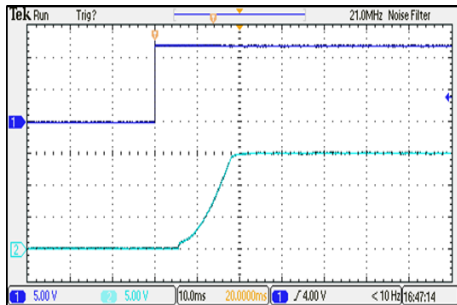

Typical Input Start-Up and Output Rise Characteristic
 $V_{in}=V_{in\ nom}$; Full Load

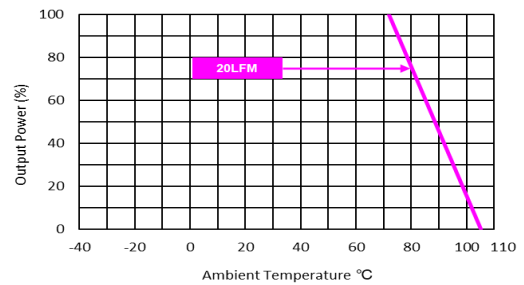

Derating Output Current Versus Ambient Temperature and Airflow
 $V_{in}=V_{in\ nom}$

Characteristic Curves

All test conditions are at 25°C The figures are identical for MDW10-12S24

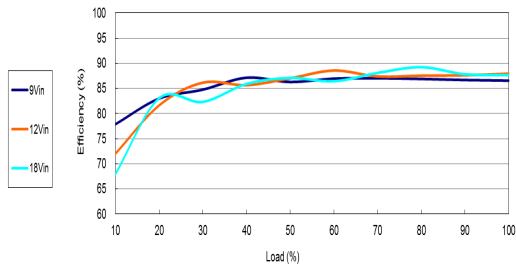

Efficiency Versus Output Current

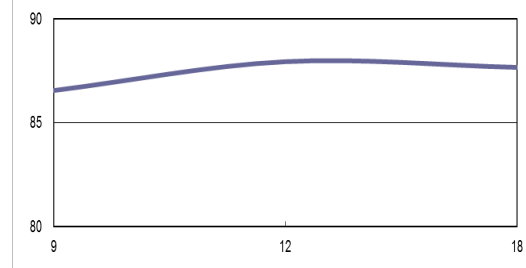

Efficiency Versus Input Voltage Full Load

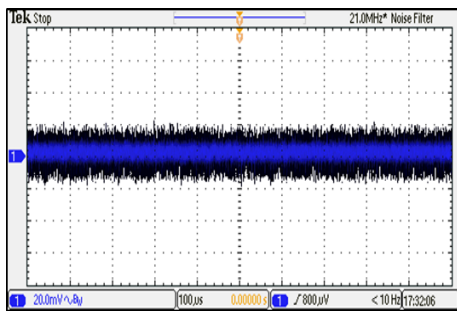

Typical Output Ripple and Noise
 $V_{in}=V_{in\ nom}$; Full Load

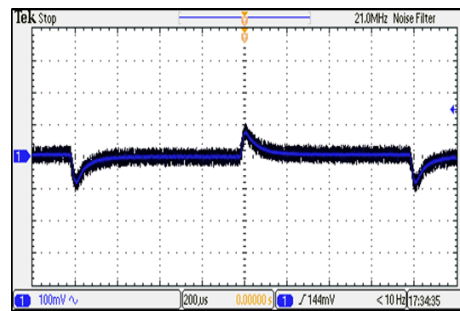

Transient Response to Dynamic Load Change
from 100% to 75% of Full Load ; $V_{in}=V_{in\ nom}$

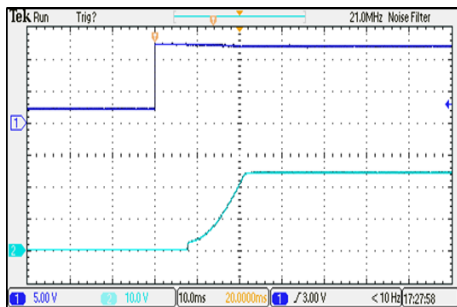

Typical Input Start-Up and Output Rise Characteristic
 $V_{in}=V_{in\ nom}$; Full Load

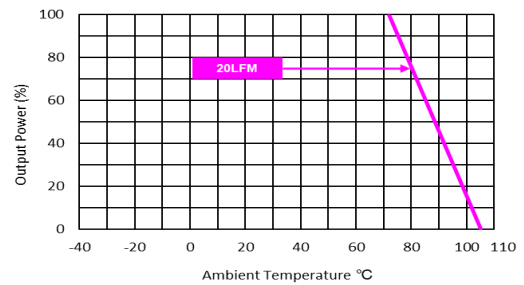

Derating Output Current Versus Ambient Temperature and Airflow
 $V_{in}=V_{in\ nom}$

Characteristic Curves

All test conditions are at 25°C The figures are identical for MDW10-12D12

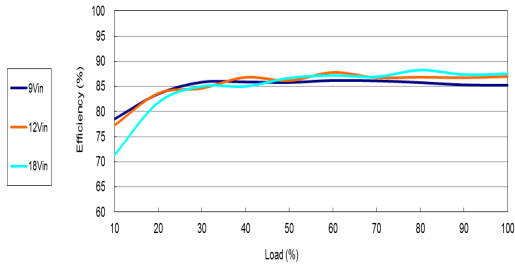

Efficiency Versus Output Current

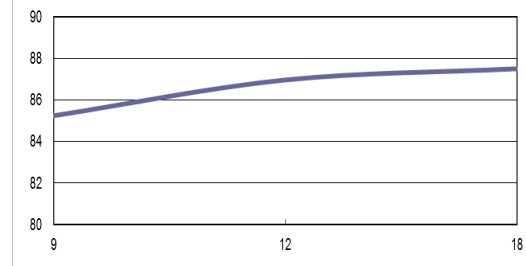

Efficiency Versus Input Voltage Full Load

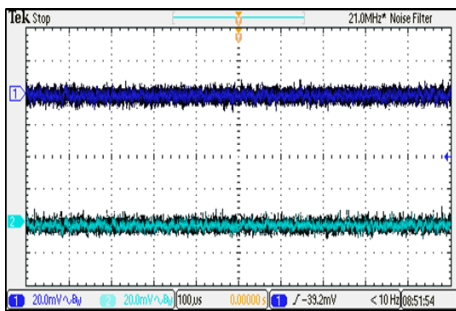

Typical Output Ripple and Noise
 $V_{in}=V_{in\ nom}$; Full Load

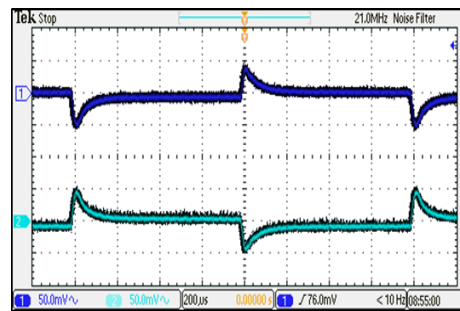

Transient Response to Dynamic Load Change
from 100% to 75% of Full Load ; $V_{in}=V_{in\ nom}$

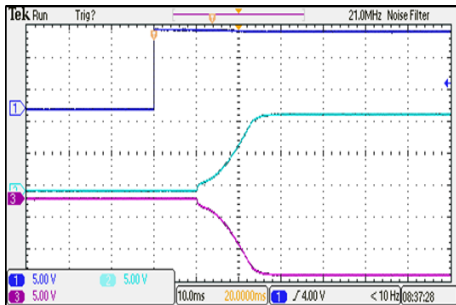

Typical Input Start-Up and Output Rise Characteristic
 $V_{in}=V_{in\ nom}$; Full Load

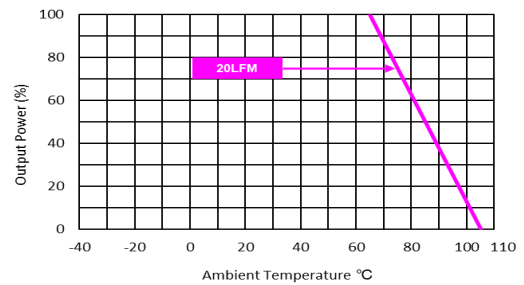

Derating Output Current Versus Ambient Temperature and Airflow
 $V_{in}=V_{in\ nom}$

Characteristic Curves

All test conditions are at 25°C The figures are identical for MDW10-12D15

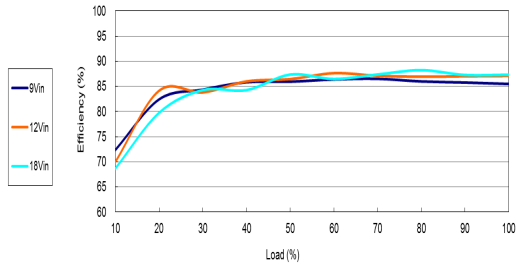

Efficiency Versus Output Current

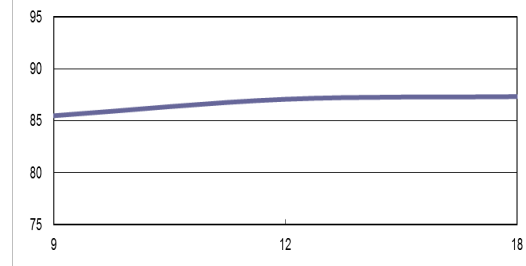

Efficiency Versus Input Voltage Full Load

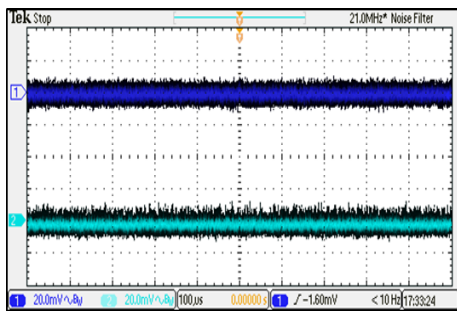

Typical Output Ripple and Noise
 $V_{in}=V_{in\ nom}$; Full Load

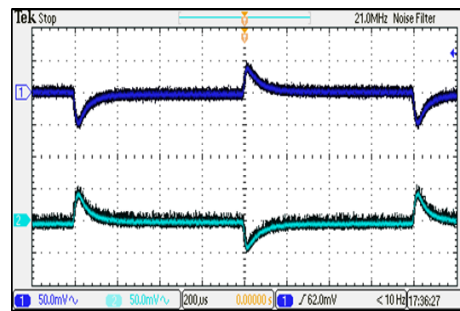

Transient Response to Dynamic Load Change
from 100% to 75% of Full Load ; $V_{in}=V_{in\ nom}$

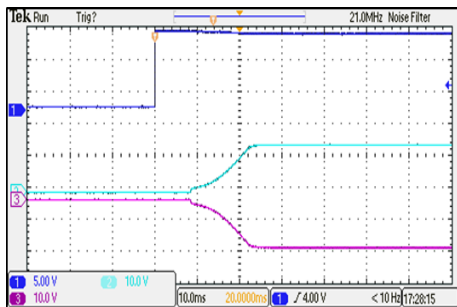

Typical Input Start-Up and Output Rise Characteristic
 $V_{in}=V_{in\ nom}$; Full Load

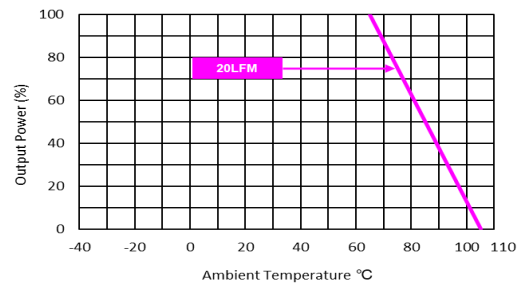

Derating Output Current Versus Ambient Temperature and Airflow
 $V_{in}=V_{in\ nom}$

Characteristic Curves

All test conditions are at 25°C The figures are identical for MDW10-24S033

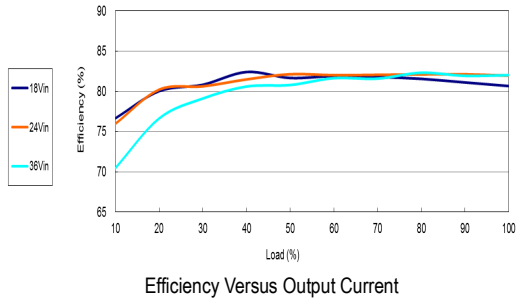

Efficiency Versus Output Current

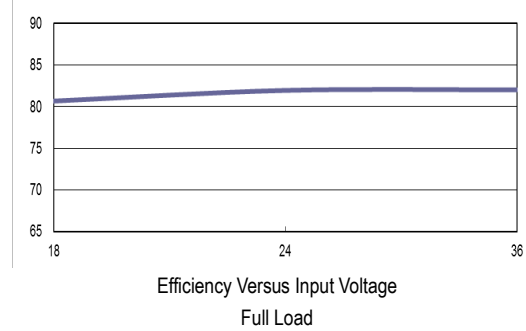

Efficiency Versus Input Voltage
Full Load

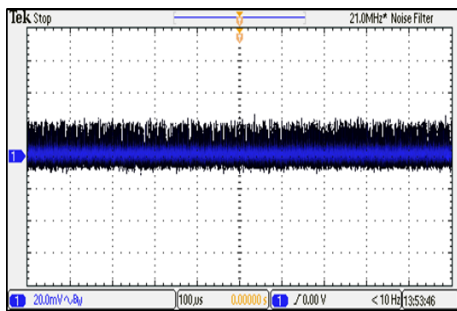

Typical Output Ripple and Noise
 $V_{in}=V_{in\ nom}$; Full Load

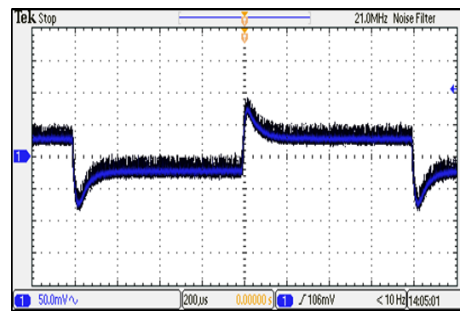

Transient Response to Dynamic Load Change
from 100% to 75% of Full Load ; $V_{in}=V_{in\ nom}$

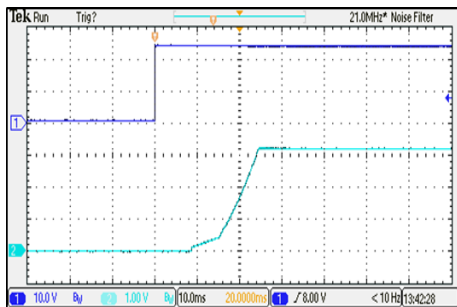

Typical Input Start-Up and Output Rise Characteristic
 $V_{in}=V_{in\ nom}$; Full Load

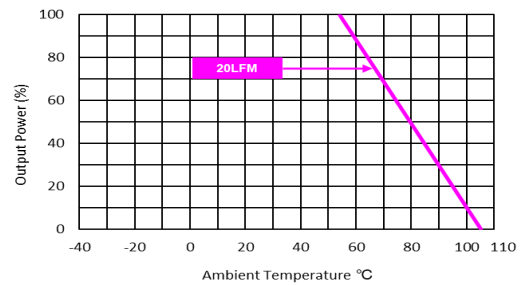

Derating Output Current Versus Ambient Temperature and Airflow
 $V_{in}=V_{in\ nom}$

Characteristic Curves

All test conditions are at 25°C The figures are identical for MDW10-24S05

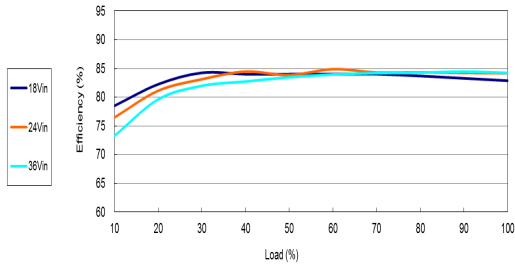

Efficiency Versus Output Current

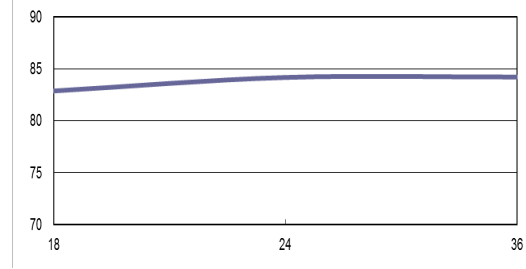

Efficiency Versus Input Voltage Full Load

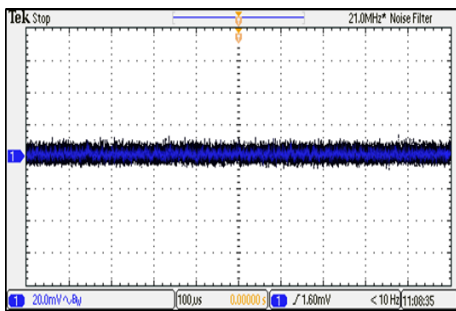

Typical Output Ripple and Noise
 $V_{in}=V_{in\ nom}$; Full Load

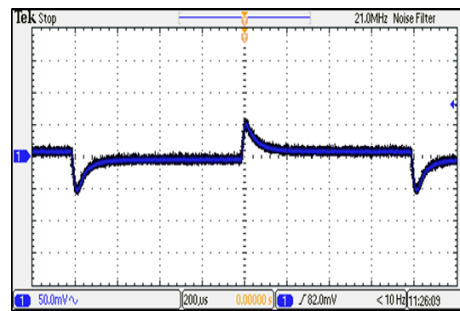

Transient Response to Dynamic Load Change
from 100% to 75% of Full Load ; $V_{in}=V_{in\ nom}$

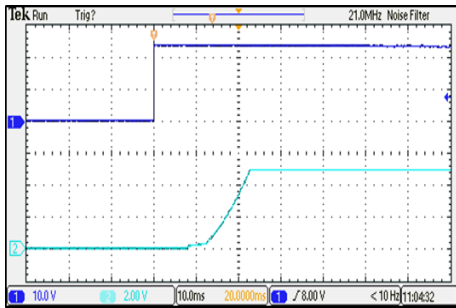

Typical Input Start-Up and Output Rise Characteristic
 $V_{in}=V_{in\ nom}$; Full Load

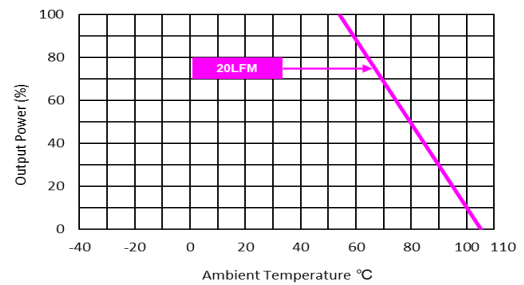

Derating Output Current Versus Ambient Temperature and Airflow
 $V_{in}=V_{in\ nom}$

Characteristic Curves

All test conditions are at 25°C The figures are identical for MDW10-24S051

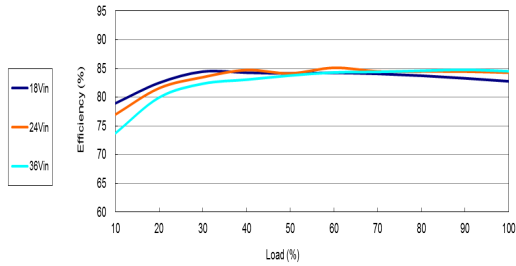

Efficiency Versus Output Current

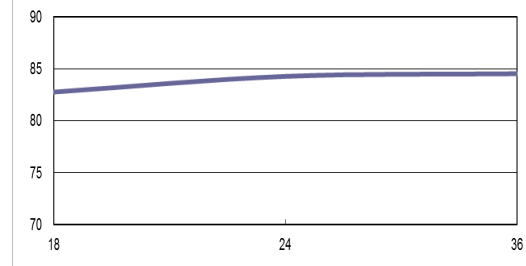

Efficiency Versus Input Voltage Full Load

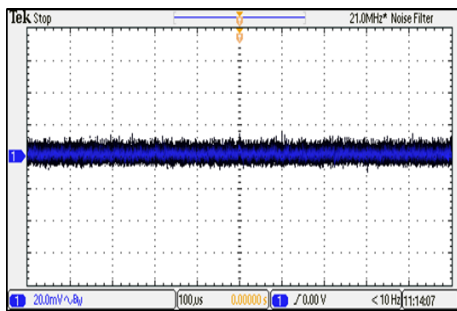

Typical Output Ripple and Noise
 $V_{in}=V_{in\ nom}$; Full Load

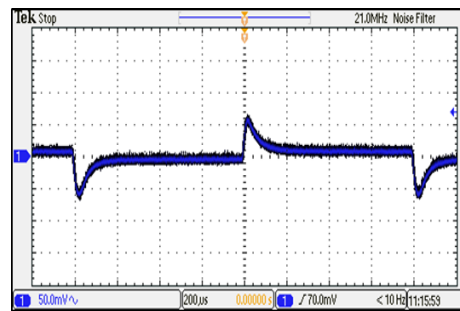

Transient Response to Dynamic Load Change
from 100% to 75% of Full Load ; $V_{in}=V_{in\ nom}$

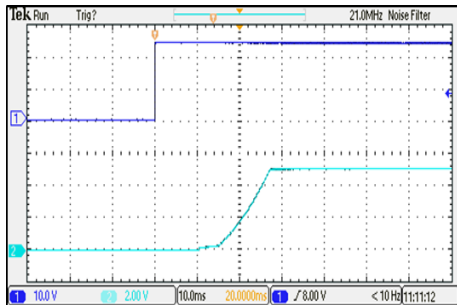

Typical Input Start-Up and Output Rise Characteristic
 $V_{in}=V_{in\ nom}$; Full Load

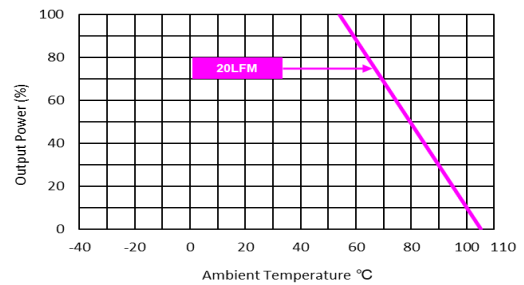

Derating Output Current Versus Ambient Temperature and Airflow
 $V_{in}=V_{in\ nom}$

Characteristic Curves

All test conditions are at 25°C The figures are identical for MDW10-24S12

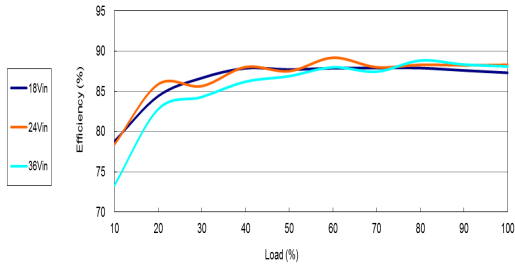

Efficiency Versus Output Current

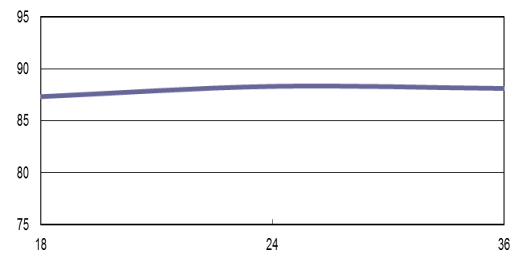

Efficiency Versus Input Voltage Full Load

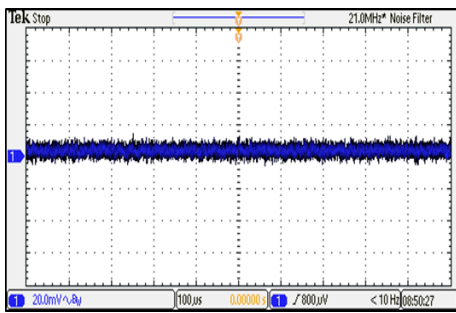

Typical Output Ripple and Noise
 $V_{in}=V_{in\ nom}$; Full Load

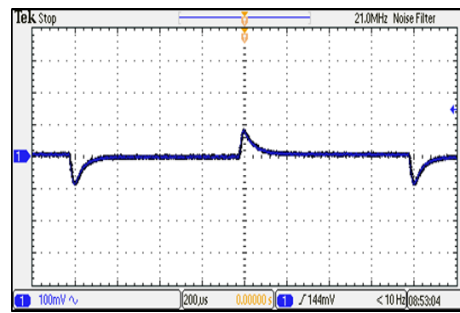

Transient Response to Dynamic Load Change
from 100% to 75% of Full Load ; $V_{in}=V_{in\ nom}$

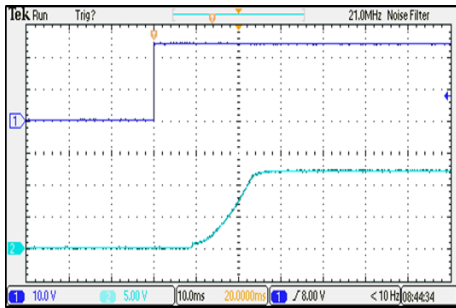

Typical Input Start-Up and Output Rise Characteristic
 $V_{in}=V_{in\ nom}$; Full Load

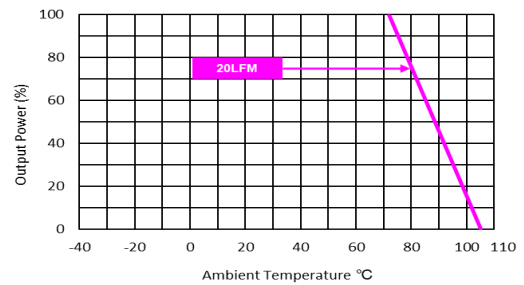

Derating Output Current Versus Ambient Temperature and Airflow
 $V_{in}=V_{in\ nom}$

Characteristic Curves

All test conditions are at 25°C The figures are identical for MDW10-24S15

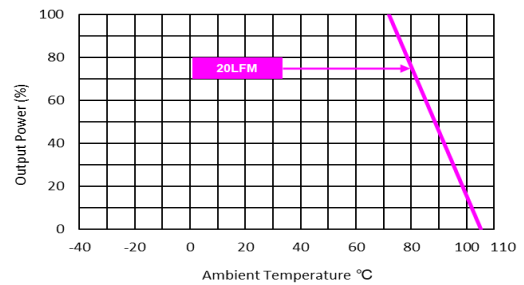
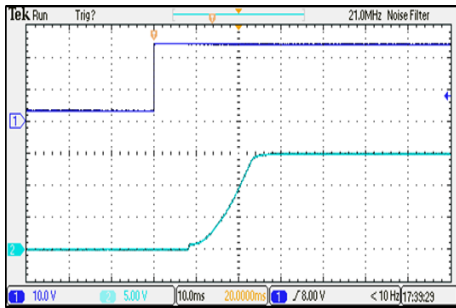
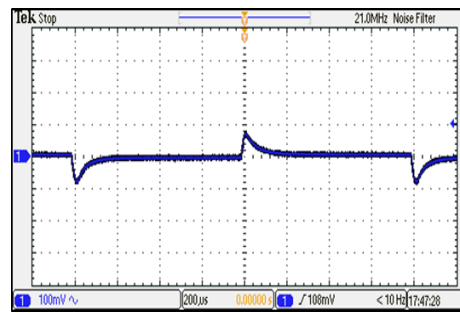
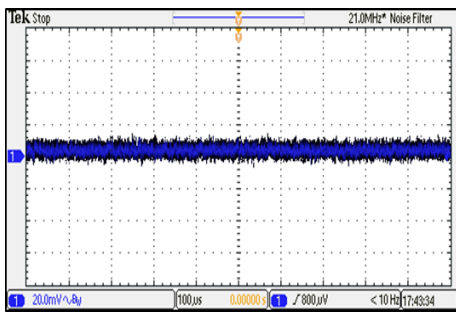
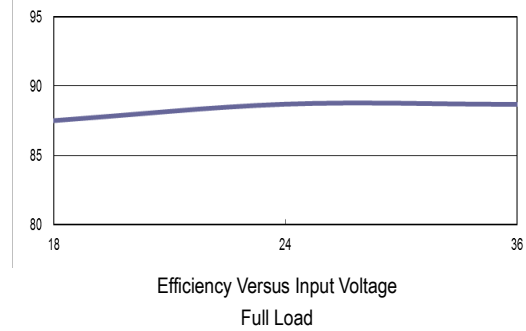
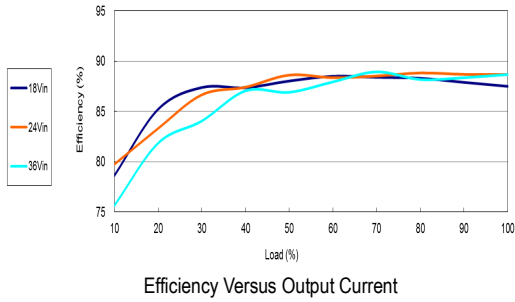

Characteristic Curves

All test conditions are at 25°C The figures are identical for MDW10-24S24

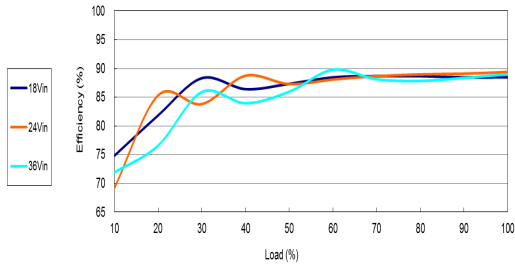

Efficiency Versus Output Current

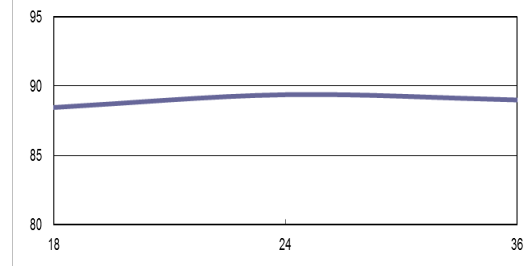

Efficiency Versus Input Voltage Full Load

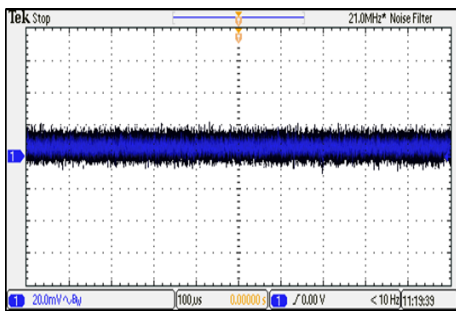

Typical Output Ripple and Noise
 $V_{in}=V_{in\ nom}$; Full Load

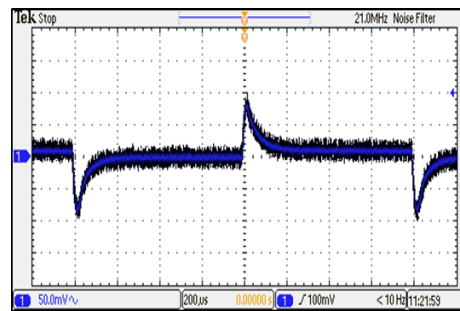

Transient Response to Dynamic Load Change
from 100% to 75% of Full Load ; $V_{in}=V_{in\ nom}$

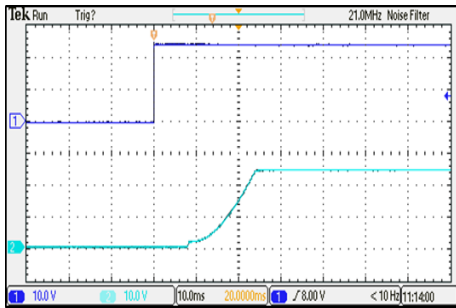

Typical Input Start-Up and Output Rise Characteristic
 $V_{in}=V_{in\ nom}$; Full Load

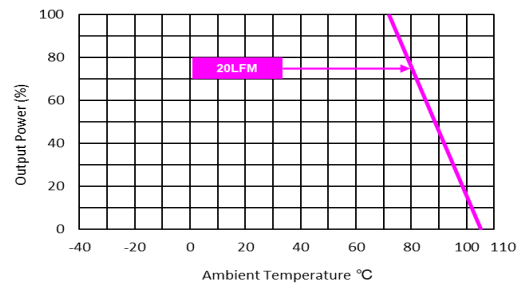

Derating Output Current Versus Ambient Temperature and Airflow
 $V_{in}=V_{in\ nom}$

Characteristic Curves

All test conditions are at 25°C The figures are identical for MDW10-24D12

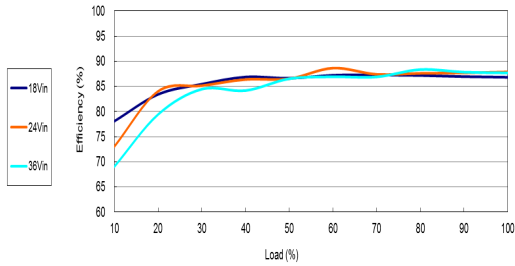

Efficiency Versus Output Current

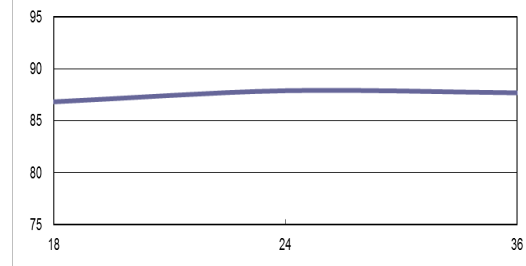

Efficiency Versus Input Voltage
Full Load

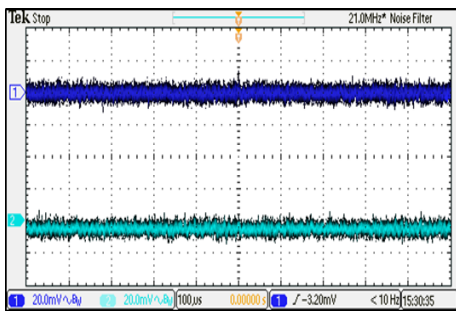

Typical Output Ripple and Noise
 $V_{in}=V_{in\ nom}$; Full Load

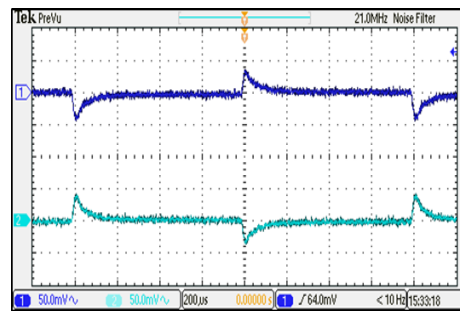

Transient Response to Dynamic Load Change
from 100% to 75% of Full Load ; $V_{in}=V_{in\ nom}$

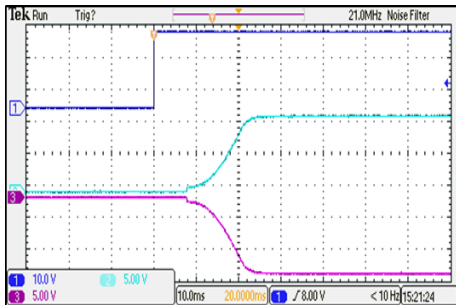

Typical Input Start-Up and Output Rise Characteristic
 $V_{in}=V_{in\ nom}$; Full Load

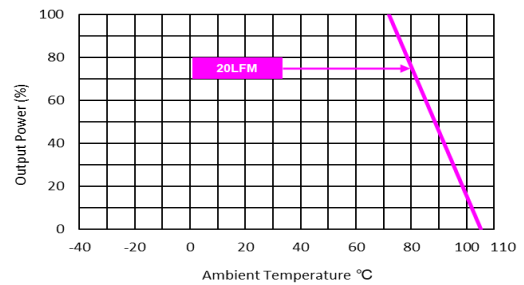

Derating Output Current Versus Ambient Temperature and Airflow
 $V_{in}=V_{in\ nom}$

Characteristic Curves

All test conditions are at 25°C The figures are identical for MDW10-24D15

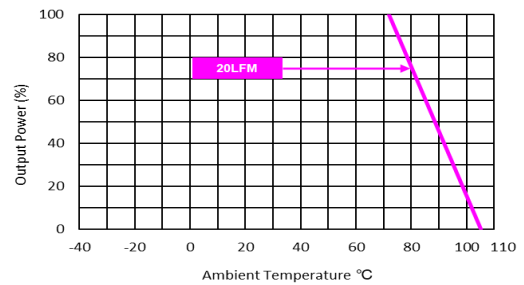
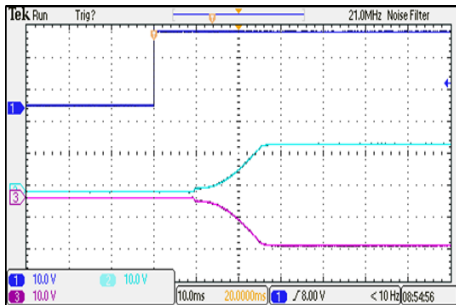
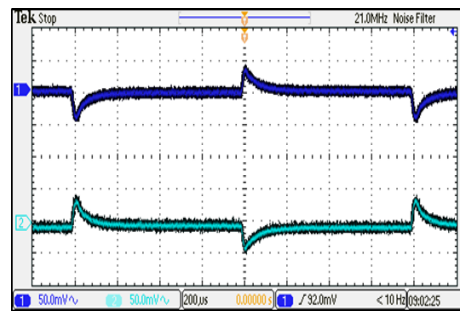
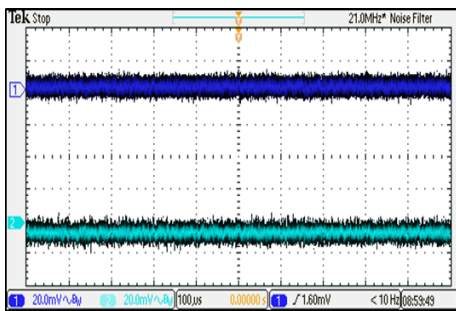
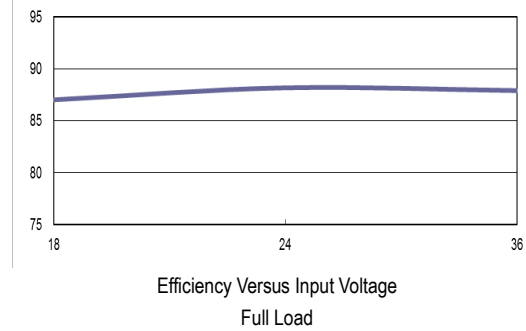
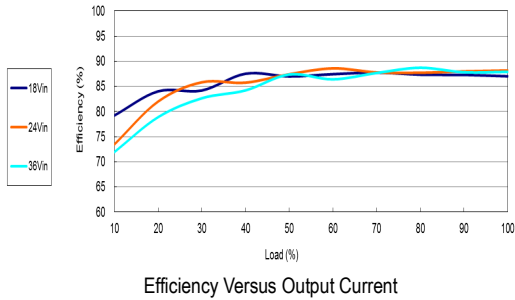

Characteristic Curves

All test conditions are at 25°C The figures are identical for MDW10-48S033

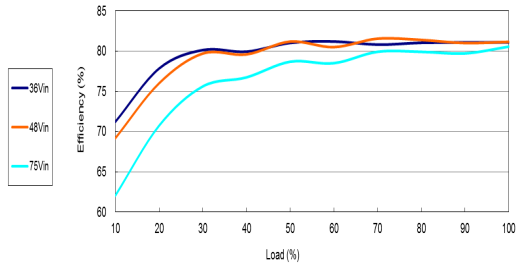

Efficiency Versus Output Current

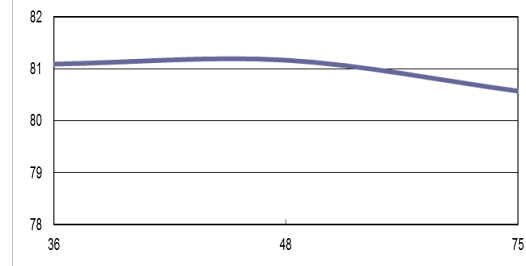

Efficiency Versus Input Voltage Full Load

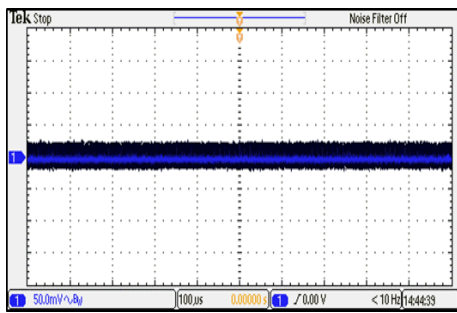

Typical Output Ripple and Noise
 $V_{in}=V_{in\ nom}$; Full Load

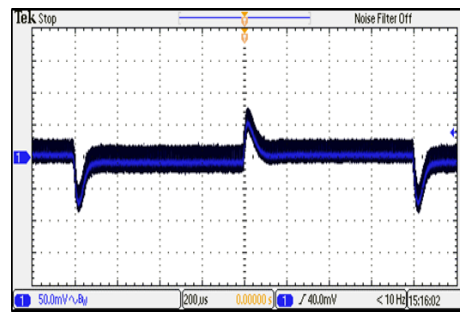

Transient Response to Dynamic Load Change
from 100% to 75% of Full Load ; $V_{in}=V_{in\ nom}$

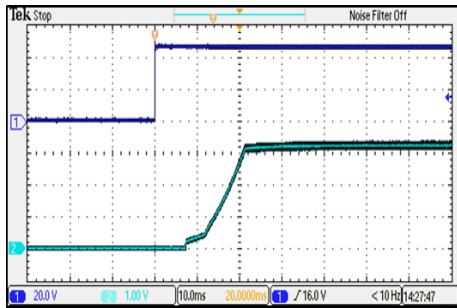

Typical Input Start-Up and Output Rise Characteristic
 $V_{in}=V_{in\ nom}$; Full Load

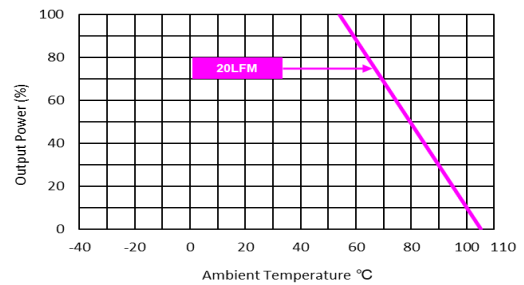

Derating Output Current Versus Ambient Temperature and Airflow
 $V_{in}=V_{in\ nom}$

Characteristic Curves

All test conditions are at 25°C The figures are identical for MDW10-48S05

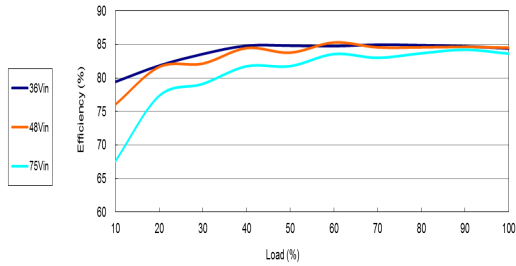

Efficiency Versus Output Current

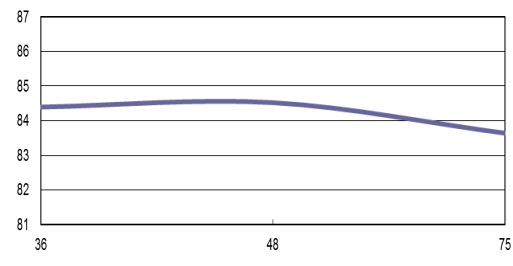

Efficiency Versus Input Voltage Full Load

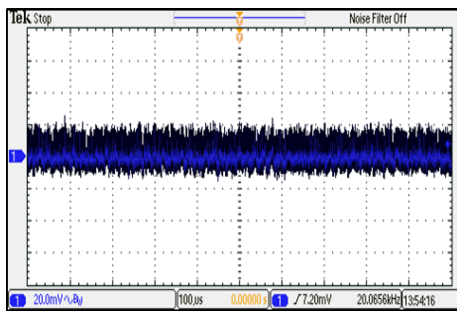

Typical Output Ripple and Noise
 $V_{in}=V_{in\ nom}$; Full Load

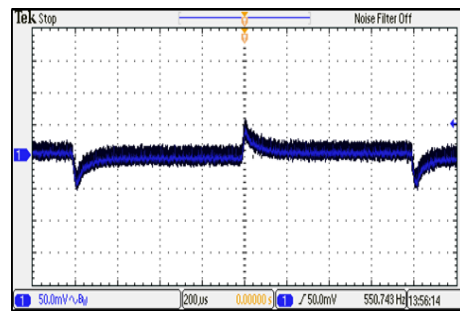

Transient Response to Dynamic Load Change
from 100% to 75% of Full Load ; $V_{in}=V_{in\ nom}$

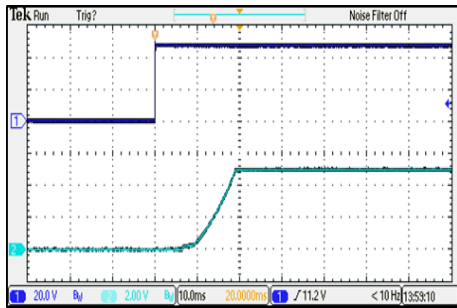

Typical Input Start-Up and Output Rise Characteristic
 $V_{in}=V_{in\ nom}$; Full Load

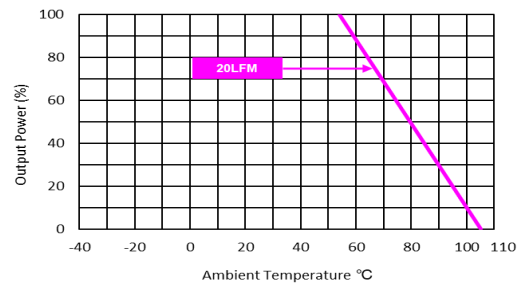

Derating Output Current Versus Ambient Temperature and Airflow
 $V_{in}=V_{in\ nom}$

Characteristic Curves

All test conditions are at 25°C The figures are identical for MDW10-48S051

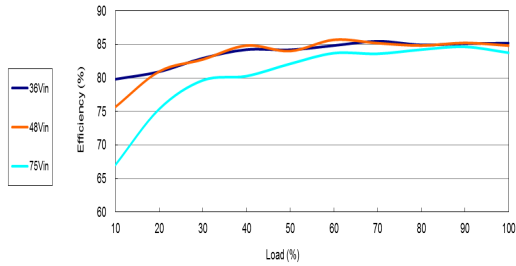

Efficiency Versus Output Current

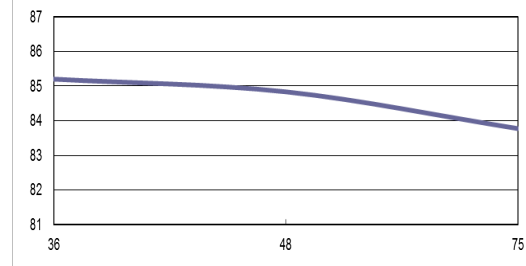

Efficiency Versus Input Voltage Full Load

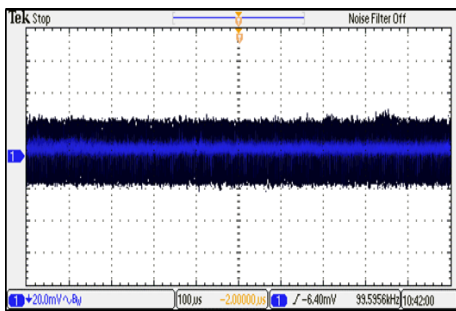

Typical Output Ripple and Noise
 $V_{in}=V_{in\ nom}$; Full Load

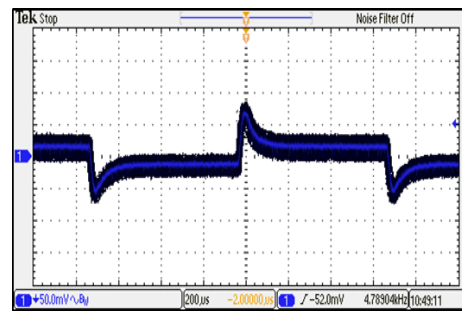

Transient Response to Dynamic Load Change
from 100% to 75% of Full Load ; $V_{in}=V_{in\ nom}$

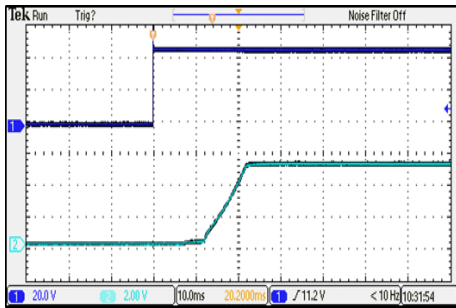

Typical Input Start-Up and Output Rise Characteristic
 $V_{in}=V_{in\ nom}$; Full Load

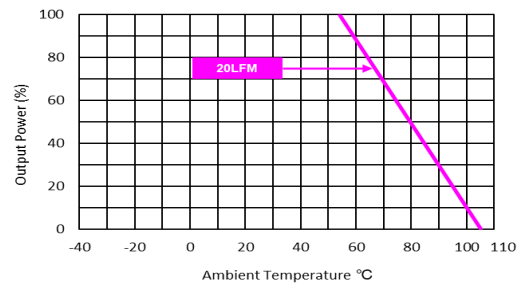

Derating Output Current Versus Ambient Temperature and Airflow
 $V_{in}=V_{in\ nom}$

Characteristic Curves

All test conditions are at 25°C The figures are identical for MDW10-48S12

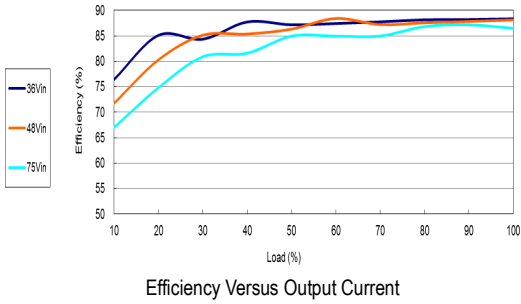

Efficiency Versus Output Current

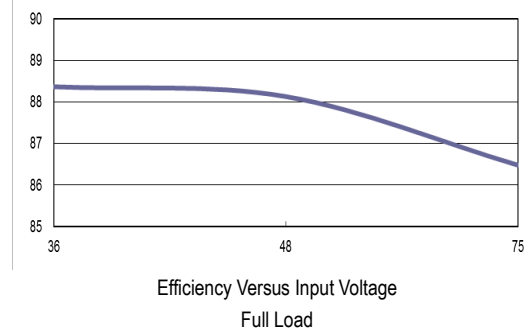

Efficiency Versus Input Voltage Full Load

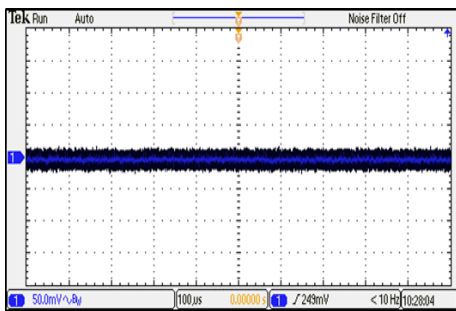

Typical Output Ripple and Noise
 $V_{in}=V_{in\ nom}$; Full Load

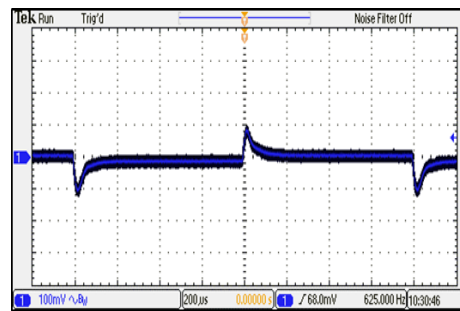

Transient Response to Dynamic Load Change
from 100% to 75% of Full Load ; $V_{in}=V_{in\ nom}$

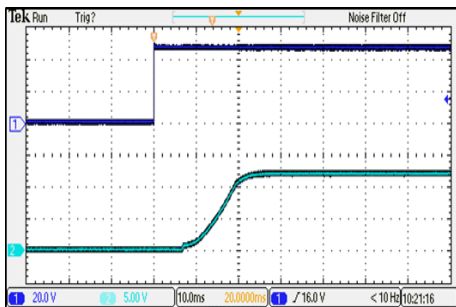

Typical Input Start-Up and Output Rise Characteristic
 $V_{in}=V_{in\ nom}$; Full Load

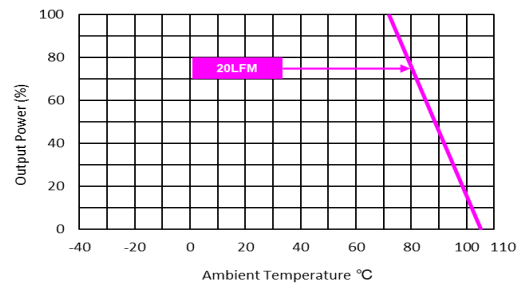

Derating Output Current Versus Ambient Temperature and Airflow
 $V_{in}=V_{in\ nom}$

Characteristic Curves

All test conditions are at 25°C The figures are identical for MDW10-48S15

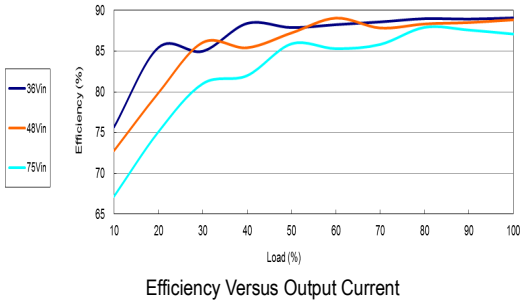

Efficiency Versus Output Current

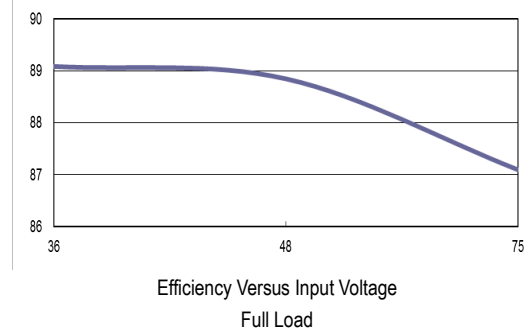

Efficiency Versus Input Voltage Full Load

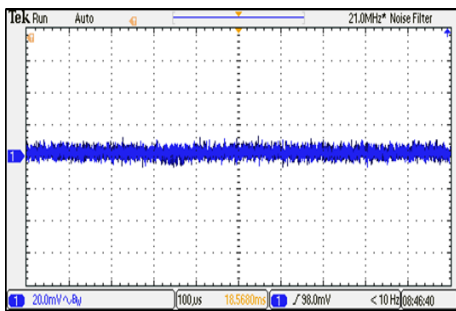

Typical Output Ripple and Noise
 $V_{in}=V_{in\ nom}$; Full Load

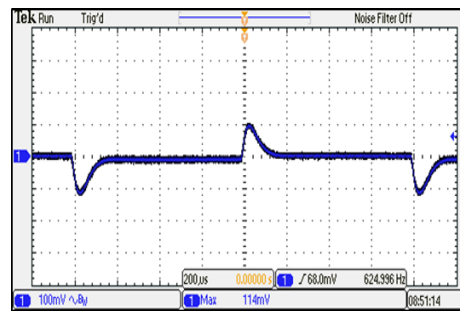

Transient Response to Dynamic Load Change
from 100% to 75% of Full Load ; $V_{in}=V_{in\ nom}$

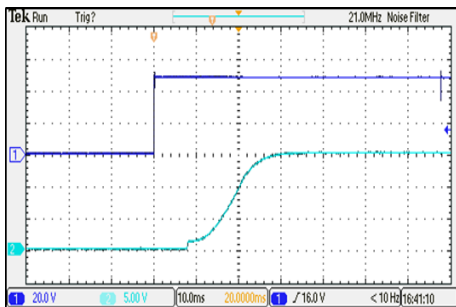

Typical Input Start-Up and Output Rise Characteristic
 $V_{in}=V_{in\ nom}$; Full Load

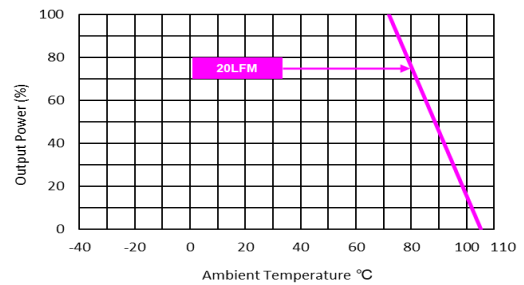

Derating Output Current Versus Ambient Temperature and Airflow
 $V_{in}=V_{in\ nom}$

Characteristic Curves

All test conditions are at 25°C The figures are identical for MDW10-48S24

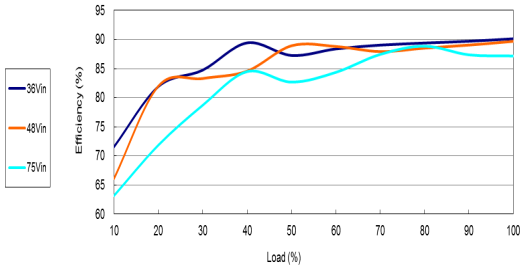

Efficiency Versus Output Current

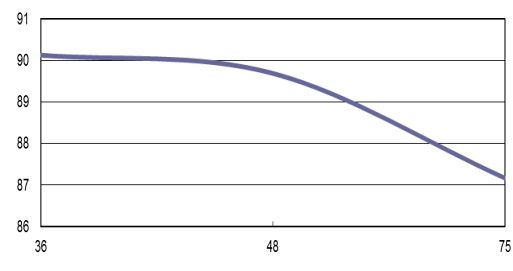

Efficiency Versus Input Voltage Full Load

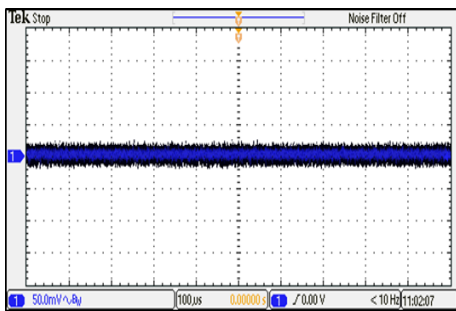

Typical Output Ripple and Noise
 $V_{in}=V_{in\ nom}$; Full Load

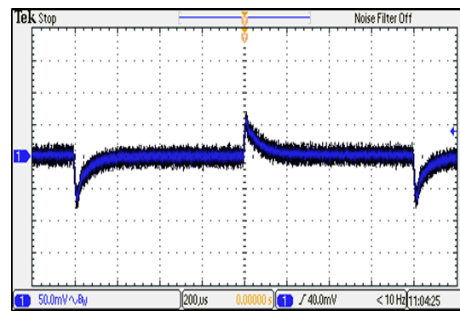

Transient Response to Dynamic Load Change
from 100% to 75% of Full Load; $V_{in}=V_{in\ nom}$

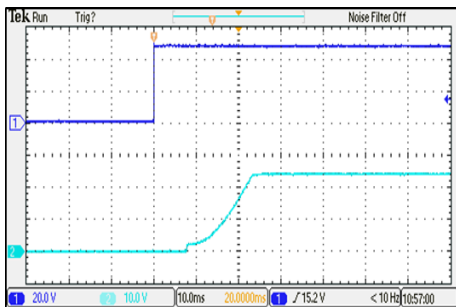

Typical Input Start-Up and Output Rise Characteristic
 $V_{in}=V_{in\ nom}$; Full Load

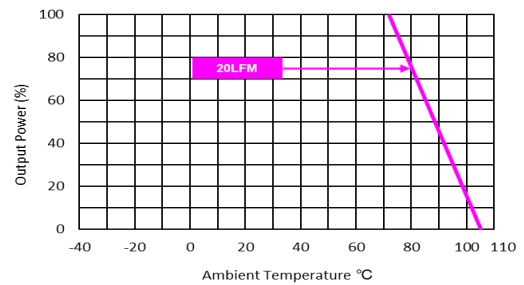

Derating Output Current Versus Ambient Temperature and Airflow
 $V_{in}=V_{in\ nom}$

Characteristic Curves

All test conditions are at 25°C The figures are identical for MDW10-48D12

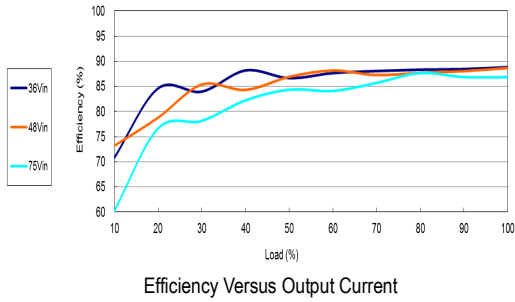

Efficiency Versus Output Current

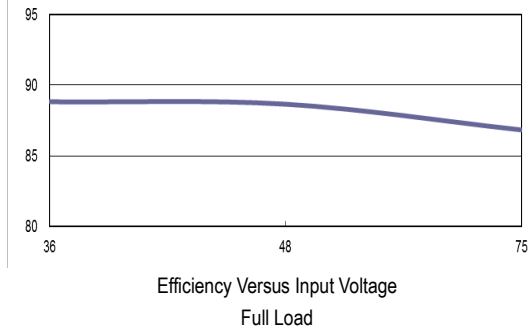

Efficiency Versus Input Voltage Full Load

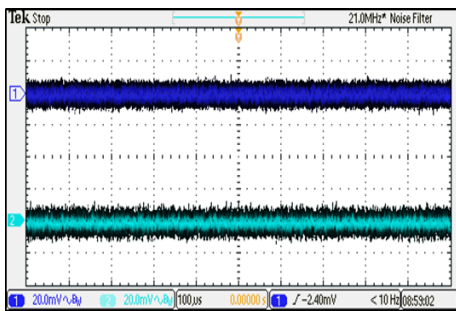

Typical Output Ripple and Noise
 $V_{in}=V_{in\ nom}$; Full Load

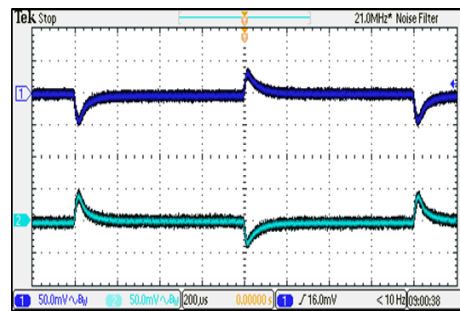

Transient Response to Dynamic Load Change
from 100% to 75% of Full Load; $V_{in}=V_{in\ nom}$

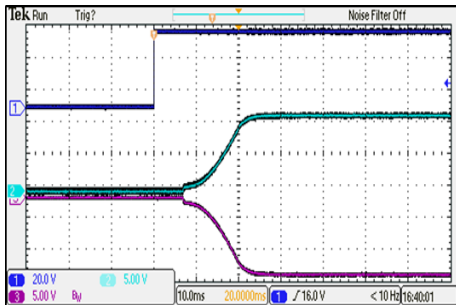

Typical Input Start-Up and Output Rise Characteristic
 $V_{in}=V_{in\ nom}$; Full Load

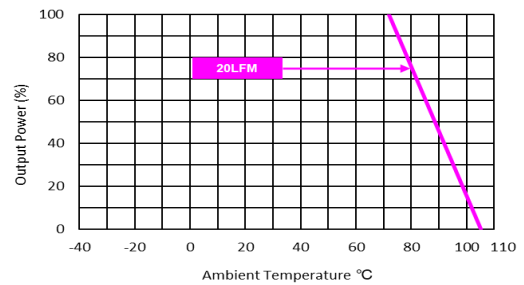

Derating Output Current Versus Ambient Temperature and Airflow
 $V_{in}=V_{in\ nom}$

Characteristic Curves

All test conditions are at 25°C The figures are identical for MDW10-48D15

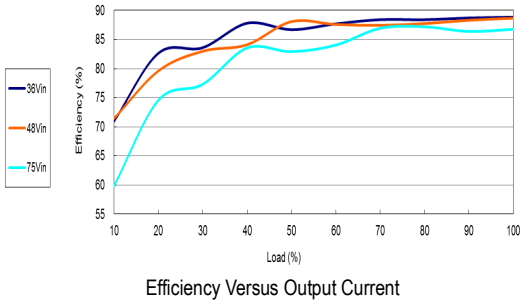

Efficiency Versus Output Current

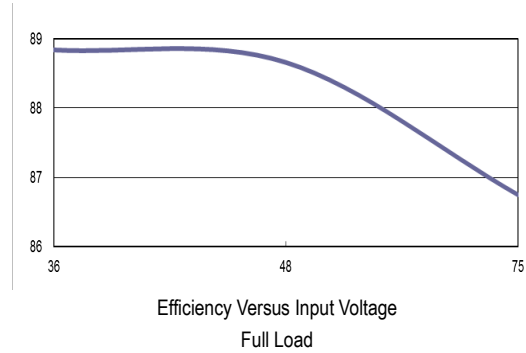

Efficiency Versus Input Voltage Full Load

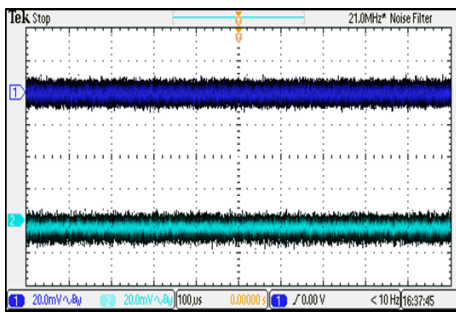

Typical Output Ripple and Noise
 $V_{in}=V_{in\ nom}$; Full Load

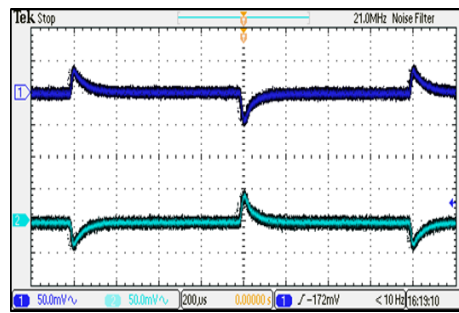

Transient Response to Dynamic Load Change
from 100% to 75% of Full Load ; $V_{in}=V_{in\ nom}$

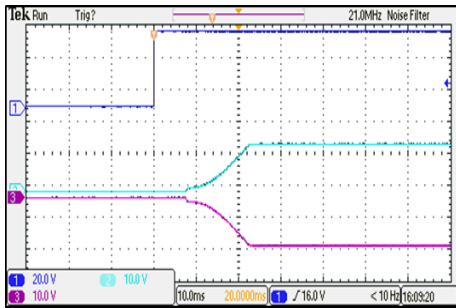

Typical Input Start-Up and Output Rise Characteristic
 $V_{in}=V_{in\ nom}$; Full Load

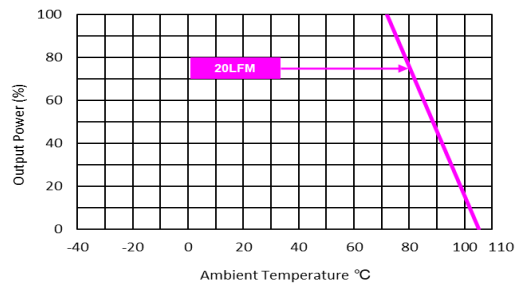

Derating Output Current Versus Ambient Temperature and Airflow
 $V_{in}=V_{in\ nom}$

Package Specifications

Mechanical Dimensions

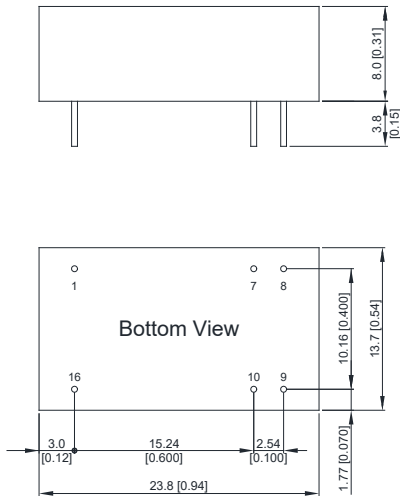

Pin Connections

Pin	Single Output	Dual Output	Diameter mm (inches)
1	-Vin	-Vin	∅ 0.5 [0.02]
7	NC	NC	∅ 0.5 [0.02]
8	NC	Common	∅ 0.5 [0.02]
9	+Vout	+Vout	∅ 0.5 [0.02]
10	-Vout	-Vout	∅ 0.5 [0.02]
16	+Vin	+Vin	∅ 0.5 [0.02]

NC: No Connection

- ▶ All dimensions in mm (inches)
- ▶ Tolerance: X.X±0.5 (X.XX±0.02)
X.XX±0.25 (X.XXX±0.01)
- ▶ Pin diameter tolerance: X.X±0.05 (X.XX±0.002)

Physical Characteristics

Case Size	: 23.8x13.7x8.0 mm (0.94x0.54x0.31 inches)
Case Material	: Metal With Non-Conductive Baseplate
Pin Material	: Copper Alloy
Weight	: 6.5g

Recommended Pad Layout for Single & Dual Output Converter

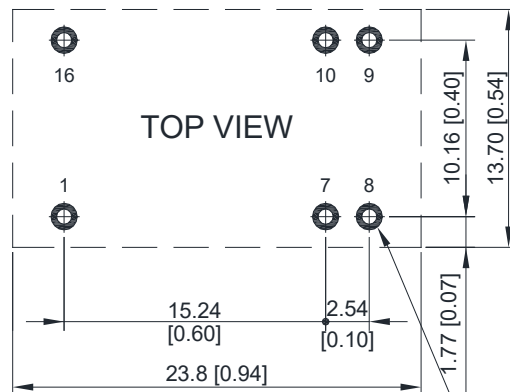

6X∅1.30±0.1(PAD)[6X∅0.05±0.004]
6X∅0.80±0.1(HOLE)[6X∅0.03±0.004]

Test Setup

Peak-to-Peak Output Noise Measurement Test

Refer to the output specifications or add 4.7 μ F capacitor if the output specifications undefine C_{out}. Scope measurement should be made by using a BNC socket, measurement bandwidth is 0-20 MHz. Position the load between 50 mm and 75 mm from the DC-DC Converter.

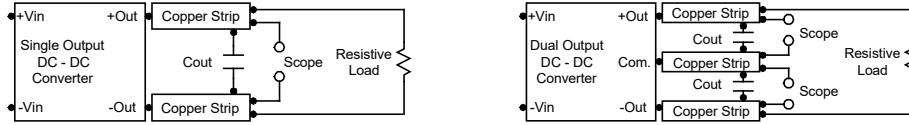

Technical Notes

Overload Protection

To provide hiccup mode protection in a fault (output overload) condition, the unit is equipped with internal current limiting circuitry and can endure overload for an unlimited duration.

Input Source Impedance

The power module should be connected to a low ac-impedance input source. Highly inductive source impedances can affect the stability of the power module. In applications where power is supplied over long lines and output loading is high, it may be necessary to use a capacitor on the input to insure startup. By using a good quality low Equivalent Series Resistance (ESR < 1.0 Ω at 100 kHz) capacitor of a 2.2 μ F for the 12V, 24V and 48V input devices, capacitor mounted close to the power module helps ensure stability of the unit.

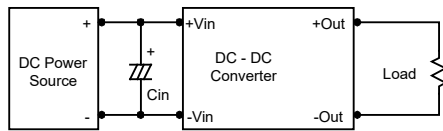

Output Ripple Reduction

A good quality low ESR capacitor placed as close as practicable across the load will give the best ripple and noise performance. To reduce output ripple, it is recommended to use 3.3 μ F capacitors at the output.

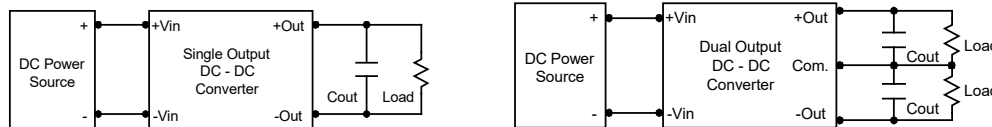

Maximum Capacitive Load

The MDW10 series has limitation of maximum connected capacitance on the output. The power module may operate in current limiting mode during start-up, affecting the ramp-up and the startup time. Connect capacitors at the point of load for best performance. The maximum capacitance can be found in the data sheet.

Thermal Considerations

Many conditions affect the thermal performance of the power module, such as orientation, airflow over the module and board spacing. To avoid exceeding the maximum temperature rating of the components inside the power module, the case temperature must be kept below 105°C. The derating curves are determined from measurements obtained in a test setup.

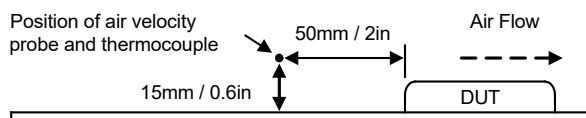

Packaging Information for Tube

Tube

Plug

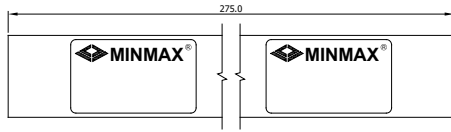
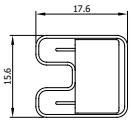

Unit: mm
10 PCS per TUBE

Wave Soldering Considerations

Lead free wave solder profile

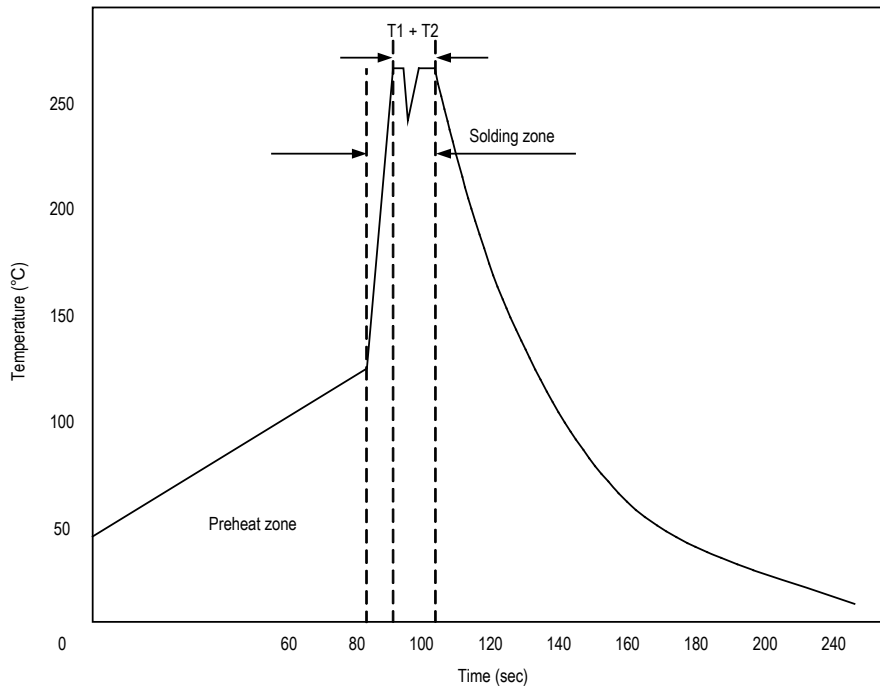

Zone	Reference Parameter
Preheat	Rise temp. speed : 3°C/sec max.
zone	Preheat temp. : 100~130°C
Actual	Peak temp. : 250~260°C
heating	Peak time(T1+T2) : 4~6 sec

Hand Welding Parameter

Reference Solder: Sn-Ag-Cu : Sn-Cu : Sn-Ag

Hand Welding: Soldering iron : Power 60W

Welding Time: 2~4 sec

Temp.: 380~400°C

Part Number Structure

M	D	W	10	-	12	S	033
Package Type DIP-16	Wide 2:1 Input Voltage Range	Output Power 10 Watt			Input Voltage Range 12: 9 ~ 18 VDC 24: 18 ~ 36 VDC 48: 36 ~ 75 VDC	Output Quantity S: Single D: Dual	Output Voltage 033: 3.3 VDC 05: 5 VDC 051: 5.1 VDC 12: 12 VDC 15: 15 VDC 24: 24 VDC

MTBF and Reliability

The MTBF of MDW10 series of DC-DC converters has been calculated using

MIL-HDBK 217F NOTICE2, Operating Temperature 25°C, Ground Benign.

Model	MTBF	Unit
MDW10-12S033	1,817,895	Hours
MDW10-12S05	1,827,687	
MDW10-12S051	1,814,779	
MDW10-12S12	2,731,684	
MDW10-12S15	2,913,675	
MDW10-12S24	2,971,325	
MDW10-12D12	2,714,159	
MDW10-12D15	2,694,724	
MDW10-24S033	1,983,726	
MDW10-24S05	1,995,845	
MDW10-24S051	2,000,062	
MDW10-24S12	2,963,950	
MDW10-24S15	3,149,204	
MDW10-24S24	3,205,296	
MDW10-24D12	2,935,513	
MDW10-24D15	2,911,181	
MDW10-48S033	1,984,208	
MDW10-48S05	2,000,152	
MDW10-48S051	1,987,283	
MDW10-48S12	2,965,960	
MDW10-48S15	3,148,532	
MDW10-48S24	3,209,374	
MDW10-48D12	2,938,701	
MDW10-48D15	2,917,626	