



MINMAX[®]

MKW15M Series - EMC Notes

MKW15M Series - EMC Notes

External Filter meets Conducted EMI EN 55011, class B ; FCC part 15 ,level B

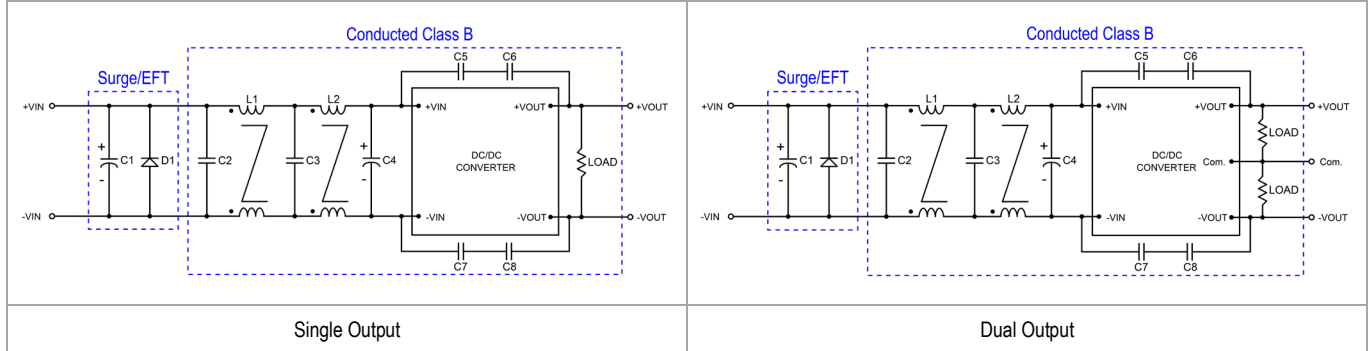

Model	Surge/EFT		Conducted Class B				
	C1	D1	C2,C3	L1	L2	C4	C5,C6,C7,C8
MKW15-12XXXM MKW15-24XXXM	560µF/50V CHEMI-CON KY Series	V15P8-M3	3.3µF/100V 1210	0.4mH/3.6A 74461240004	33mH/2.5A 7448030333	330µF/100V CHEMI-CON KY Series	2200pF/ Y1 Cap.
MKW15-48XXXM	560µF/100V CHEMI-CON KY Series	V15P10	3.3µF/100V 1210	0.4mH/3.6A 74461240004	33mH/2.5A 7448030333	330µF/100V CHEMI-CON KY Series	2200pF/ Y1 Cap.