

## FEATURES

- ▶ Fully Encapsulated Plastic Case for Chassis and DIN-Rail Mounting Version
- ▶ Ultra-wide 4:1 Input Voltage Range
- ▶ Fully Regulated Output Voltage
- ▶ Excellent Efficiency up to 92%
- ▶ I/O Isolation 2500 VDC
- ▶ Operating Ambient Temp. Range -40°C to +85°C
- ▶ Under-voltage, Overload/Voltage and Short Circuit Protection
- ▶ No Min. Load Requirement
- ▶ Remote On/Off Control
- ▶ Conducted EMI EN 55032 Class A Approved
- ▶ EMC Immunity EN 61000-4-2,3,4,5,6,8 Approved
- ▶ UL/cUL/IEC/EN 62368-1(60950-1) Safety Approval & CE Marking



## PRODUCT OVERVIEW

The MINMAX MQWI40C series is a range of regulated DC-DC converter modules with ultra-wide 4:1 input voltage ranges. The product comes in a fully encapsulated module with the screw terminal block and it's suitable for chassis or DIN-Rail mounting which is easy to install. Featuring an extended operating temperature range from -40°C to +85°C, EMC compliance to EN 61000-6-1 standard these modules have been designed particularly for industrial applications.

### Model Selection Guide

Model Number	Input Voltage (Range)	Output Voltage	Output Current	Input Current		Max. capacitive Load	Efficiency (typ.)
				Max.			
				mA(typ.)	@ Max. Load		
MQWI40-24S051C	24 (9 ~ 36)	5.1	8000	1889	90	13600	90
MQWI40-24S12C		12	3330	1850	90	2400	90
MQWI40-24S24C		24	1670	1856	90	600	90
MQWI40-24S48C		48	835	1876	90	150	89
MQWI40-48S051C	48 (18 ~ 75)	5.1	8000	955	55	13600	89
MQWI40-48S12C		12	3330	915	55	2400	91
MQWI40-48S24C		24	1670	908	55	600	92
MQWI40-48S48C		48	835	928	55	150	90

### Input Specifications

Parameter		Conditions / Model	Min.	Typ.	Max.	Unit
Input Surge Voltage (100 ms max.)		24V Input Models	-0.7	---	50	VDC
		48V Input Models	-0.7	---	100	
Start-Up Threshold Voltage		24V Input Models	---	---	9	
		48V Input Models	---	---	18	
Under Voltage Shutdown		24V Input Models	---	7.5	---	
		48V Input Models	---	16	---	
Start Up Time	Power Up	Nominal Vin and Constant Resistive Load	---	---	30	ms
	Remote On/Off		---	---	30	ms
Input Filter		All Models	Internal Pi Type			

Remote On/Off Control						
Parameter	Conditions	Min.	Typ.	Max.	Unit	
Converter On	3.5V ~ 12V or Open Circuit					
Converter Off	0V ~ 1.2V or Short Circuit					
Control Input Current (On)	Vctrl = 5.0V	---	---	0.5	mA	
Control Input Current (Off)	Vctrl = 0V	---	---	-0.5	mA	
Control Common	Referenced to Negative Input					
Standby Input Current	Nominal Vin	---	3	---	mA	

Output Specifications						
Parameter	Conditions / Model	Min.	Typ.	Max.	Unit	
Output Voltage Setting Accuracy		---	±2.0	---	%Vnom.	
Line Regulation	Vin=Min. to Max. @Full Load	---	±0.5	---	%	
Load Regulation	Io=0% to 100%	---	±1.0	---	%	
Minimum Load	No minimum Load Requirement					
Ripple & Noise	0-20MHz Bandwidth	5.1V Output Models	---	---	100	mV <sub>P-P</sub>
		12V & 24V Output Models	---	---	150	mV <sub>P-P</sub>
		48V Output Models	---	---	200	mV <sub>P-P</sub>
Transient Recovery Time	25% Load Step Change <sub>(2)</sub>	---	250	---	μsec	
Transient Response Deviation		---	±3	±5	%	
Over Voltage Protection	Zener diode clamp	---	120	---	% of Vo	
Temperature Coefficient		---	±0.02	---	%/°C	
Over Load Protection	Hiccup	---	150	---	%	
Short Circuit Protection	Continuous, Automatic Recovery (Hiccup Mode 0.25Hz typ.)					

General Specifications						
Parameter	Conditions	Min.	Typ.	Max.	Unit	
I/O Isolation Voltage	60 Seconds	2500	---	---	VDC	
I/O Isolation Resistance	500 VDC	1000	---	---	MΩ	
I/O Isolation Capacitance	100kHz, 1V	---	---	2400	pF	
Switching Frequency		---	285	---	kHz	
MTBF (calculated)	MIL-HDBK-217F@25°C, Ground Benign	644,290			Hours	
Safety Approvals	UL/cUL 62368-1/60950-1 recognition(UL certificate), IEC/EN 62368-1/60950-1(CB-report)					

EMC Specifications				
Parameter	Standards & Level			Performance
EMI	Conduction	EN 55032	Without external components	Class A
	Radiation		With external components	
EMS	EN 55024			
	ESD	EN 61000-4-2 Air ± 8kV , Contact ± 4kV		A
	Radiated immunity	EN 61000-4-3 10V/m		A
	Fast transient	EN 61000-4-4 ±2kV		A
	Surge	EN 61000-4-5 ±2kV		A
	Conducted immunity	EN 61000-4-6 10Vrms		A
	PFMF	EN 61000-4-8 30A/M		A

**Environmental Specifications**

Parameter	Conditions / Model	Min.	Max.	Unit
Operating Ambient Temperature Range Nominal Vin, Load 100% Inom. (for Power Derating see relative Derating Curves)	MQWI40-48S24C	-40	+78	°C
	MQWI40-48S12		+76	
	MQWI40-24S051C,24S12C		+73	
	MQWI40-24S24C,48S48C		+71	
	MQWI40-24S48C,48S051C		+71	
Thermal Impedance	20LFM Convection	4.75	---	°C/W
	100LFM Convection	3.55	---	°C/W
	200LFM Convection	3.10	---	°C/W
	400LFM Convection	1.95	---	°C/W
Case Temperature		---	+95	°C
Storage Temperature Range		-50	+125	°C
Humidity (non condensing)		---	95	% rel. H

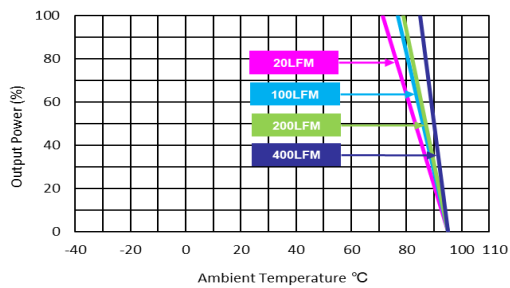
**Power Derating Curve**

MQWI40-24S48C, MQWI40-48S051C

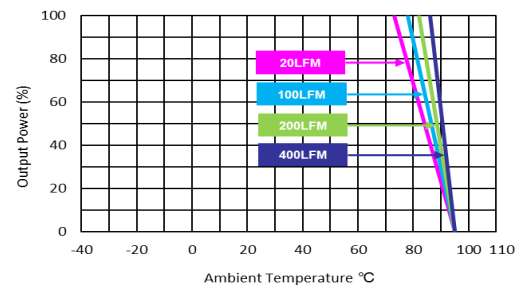

MQWI40-24S051C, MQWI40-24S12C, MQWI40-24S24C, MQWI40-48S48C

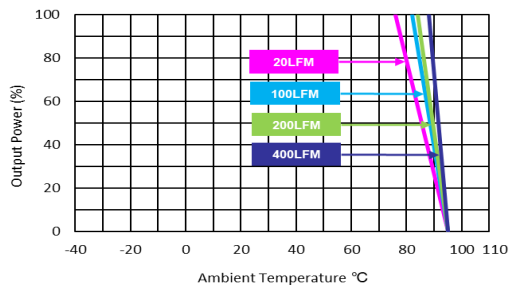

MQWI40-48S12C

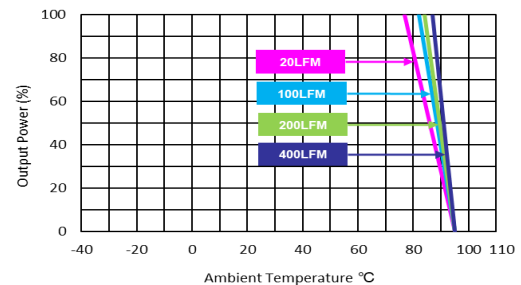

MQWI40-48S24C

**Notes**

- 1 Specifications typical at Ta=+25°C, resistive load, nominal input voltage and rated output current unless otherwise noted.
- 2 Transient recovery time is measured to within 1% error band for a step change in output load of 75% to 100%.
- 3 We recommend to protect the converter by a slow blow fuse in the input supply line.
- 4 Other input and output voltage may be available, please contact MINMAX.
- 5 Specifications are subject to change without notice.

**Package Specifications Chassis Mounting**

**Mechanical Dimensions**

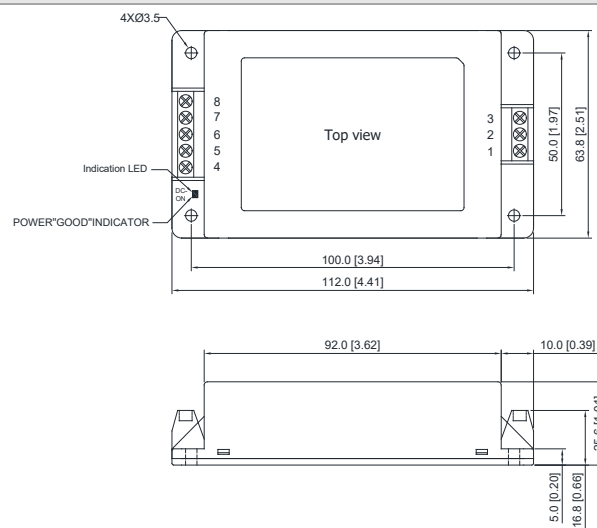

Note:

Screw type Terminal: Wires 1.5mm<sup>2</sup> max.  
 Recommended Terminal Screw tightening torque: 0.5Nm (3.5lb.in.) max.

**Connections**

Pin	Function
1	Remote On/Off
2	-Vin
3	+Vin
4	+Vout
5	NC
6	-Vout
7	NC
8	NC

NC: No Connection

▶ All dimensions in mm (inches)

▶ Tolerance: ±0.5 (±0.02)

**Physical Characteristics**

Case Size	: 112.0x63.8x25.6mm (4.41x2.51x1.01 inches)
Case Material	: Plastic resin (flammability to UL 94V-0 rated)
Weight	: 162g

**Package Specifications with DIN Rail Mounting Bracket (order code AC-DIN-02)**

**Mechanical Dimensions**

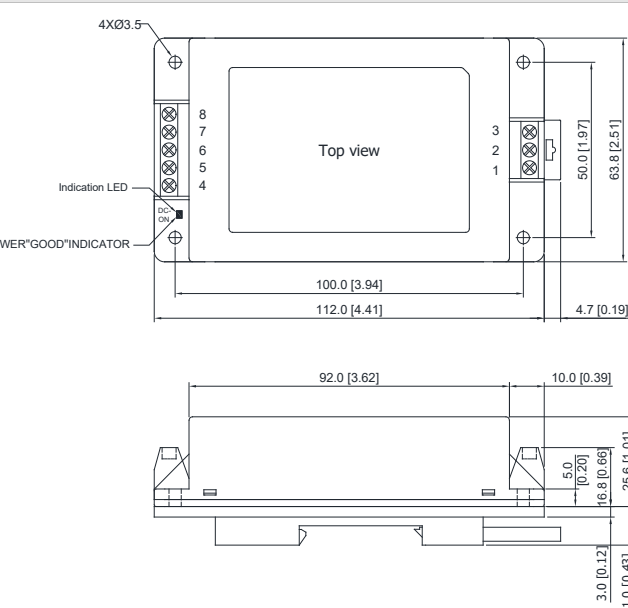
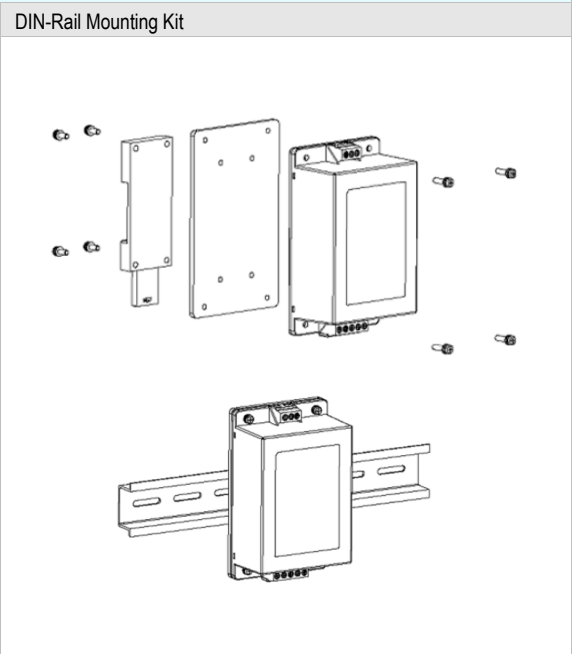

**Physical Characteristics**

Case Size	: 112.0x63.8x25.6mm (4.41x2.51x1.01 inches)
Case Material	: Plastic resin (flammability to UL 94V-0 rated)
Weight	: 216g

Order Code Table		
Standard	DIN Rail	Converter with DIN Rail Mounting
MQWI40-24S051C	AC-DIN-02	MQWI40-24S051C-DIN02
MQWI40-24S12C	AC-DIN-02	MQWI40-24S12C-DIN02
MQWI40-24S24C	AC-DIN-02	MQWI40-24S24C-DIN02
MQWI40-24S48C	AC-DIN-02	MQWI40-24S48C-DIN02
MQWI40-48S051C	AC-DIN-02	MQWI40-48S051C-DIN02
MQWI40-48S12C	AC-DIN-02	MQWI40-48S12C-DIN02
MQWI40-48S24C	AC-DIN-02	MQWI40-48S24C-DIN02
MQWI40-48S48C	AC-DIN-02	MQWI40-48S48C-DIN02

## Test Setup

### Peak-to-Peak Output Noise Measurement Test

Scope measurement should be made by using a BNC socket, measurement bandwidth is 0-20 MHz. Position the load between 50 mm and 75 mm from the DC-DC Converter.

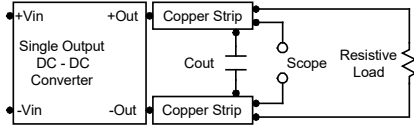

## Technical Notes

### Remote On/Off

Positive logic remote on/off turns the module on during a logic high voltage on the remote on/off pin, and off during a logic low. To turn the power module on and off, the user must supply a switch to control the voltage between the on/off terminal and the -Vin terminal. The switch can be an open collector or equivalent. A logic low is 0V to 1.2V. A logic high is 3.5V to 12V. The maximum sink current at the on/off terminal (Pin 1) during a logic low is -100 $\mu$ A.

### Overload Protection

To provide hiccup mode protection in a fault (output overload) condition, the unit is equipped with internal current limiting circuitry and can endure overload for an unlimited duration.

### Overvoltage Protection

The output overvoltage clamp consists of control circuitry, which is independent of the primary regulation loop, that monitors the voltage on the output terminals. The control loop of the clamp has a higher voltage set point than the primary loop. This provides a redundant voltage control that reduces the risk of output overvoltage. The OVP level can be found in the output data.

### Input Source Impedance

The power module should be connected to a low ac-impedance input source. Highly inductive source impedances can affect the stability of the power module. In applications where power is supplied over long lines and output loading is high, it may be necessary to use a capacitor at the input to ensure startup. Capacitor mounted close to the power module helps ensure stability of the unit, it is recommended to use a good quality low Equivalent Series Resistance (ESR < 1.0 $\Omega$  at 100 kHz) capacitor of a 10 $\mu$ F for the 24V and 48V devices.

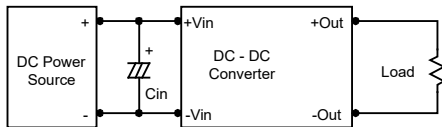

### Output Ripple Reduction

A good quality low ESR capacitor placed as close as practicable across the load will give the best ripple and noise performance. To reduce output ripple, it is recommended to use 4.7 $\mu$ F capacitors at the output.

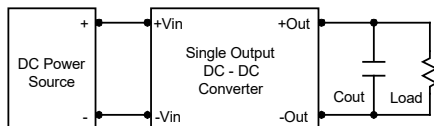

### Maximum Capacitive Load

The MQWI40C series has limitation of maximum connected capacitance at the output. The power module may be operated in current limiting mode during start-up, affecting the ramp-up and the startup time. The maximum capacitance can be found in the data sheet.

### Thermal Considerations

Many conditions affect the thermal performance of the power module, such as orientation, airflow over the module and board spacing. To avoid exceeding the maximum temperature rating of the components inside the power module, the case temperature must be kept below 95°C. The derating curves are determined from measurements obtained in a test setup.

