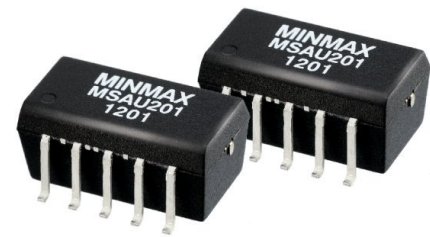

FEATURES

- ▶ Industrial SMD Package
- ▶ I/O Isolation 1000 VDC
- ▶ Operating Ambient Temp. Range -40°C to +90°C
- ▶ Water-washable Process Available
- ▶ Qualified for Lead-free Reflow Solder Process
According to IPC/JEDEC J-STD-020E
- ▶ Tape & Reel Package Available

PRODUCT OVERVIEW

The MINMAX MSAU200 series is a range of 1W DC-DC converters in a SMD- Package featuring I/O-isolation of 1000VDC. The small footprint makes this product the ideal solution for many applications where a voltage has to be isolated i.e for noise reduction, ground loop elimination, in digital interfaces or where a converted voltage is required.

An excellent efficiency allows an operating temperature range of -40°C to +90°C. These converters are fully qualified for the higher temperature profile used in lead-free reflow solder processes. For automated SMD production lines the product can also be supplied in tape& reel package.

Model Selection Guide

Model Number	Input Voltage (Range) VDC	Output Voltage VDC	Output Current		Input Current		Load Regulation % (max.)	Max. capacitive Load μF	Efficiency (typ.) @Max. Load
			Max.	Min.	@Max. Load	@No Load			
			mA	mA	mA(typ.)	mA(typ.)			%
MSAU201	5 (4.5 ~ 5.5)	±5	±100	±2	267	30	10	33	75
MSAU202		±9	±55	±1	260		10		76
MSAU203		±12	±42	±0.8	255		8		79
MSAU204		±15	±33	±0.7	251		7		79
MSAU211	12 (10.8 ~ 13.2)	±5	±100	±2	111	15	8	33	75
MSAU212		±9	±55	±1	109		8		76
MSAU213		±12	±42	±0.8	105		5		80
MSAU214		±15	±33	±0.7	103		5		80
MSAU221	24 (21.6 ~ 26.4)	±5	±100	±2	56	9	8	33	74
MSAU222		±9	±55	±1	55		8		75
MSAU223		±12	±42	±0.8	53		5		79
MSAU224		±15	±33	±0.7	52		5		79

Input Specifications

Parameter	Model	Min.	Typ.	Max.	Unit
Input Voltage Range	5V Input Models	4.5	5	5.5	VDC
	12V Input Models	10.8	12	13.2	
	24V Input Models	21.6	24	26.4	
Input Surge Voltage (1 sec. max.)	5V Input Models	-0.7	---	9	
	12V Input Models	-0.7	---	18	
	24V Input Models	-0.7	---	30	
Input Filter	All Models	Internal Capacitor			

Output Specifications

Parameter	Conditions	Min.	Typ.	Max.	Unit
Output Voltage Setting Accuracy		---	±1.0	±3.0	%Vnom.
Output Voltage Balance	Dual Output, Balanced Loads	---	±0.1	±1.0	%
Line Regulation	For Vin Change of 1%	---	±1.2	±1.5	%
Load Regulation	Io=20% to 100%	See Model Selection Guide			
Ripple & Noise	0-20 MHz Bandwidth	---	---	120	mV _{P-P}
Temperature Coefficient		---	±0.01	±0.02	%/°C
Short Circuit Protection	0.5 Second Max., Automatic Recovery				

General Specifications

Parameter	Conditions	Min.	Typ.	Max.	Unit
I/O Isolation Voltage	60 Seconds	1000	---	---	VDC
	1 Second	1200	---	---	VDC
I/O Isolation Resistance	500 VDC	1000	---	---	MΩ
I/O Isolation Capacitance	100kHz, 1V	---	40	100	pF
Switching Frequency		50	100	140	kHz
MTBF (calculated)	MIL-HDBK-217F@25°C, Ground Benign	2,000,000			Hours
Moisture Sensitivity Level (MSL)	IPC/JEDEC J-STD-020E	Level 3			

Environmental Specifications

Parameter	Conditions	Min.	Max.	Unit
Operating Ambient Temperature Range (See Power Derating Curve)		-40	+85	°C
Case Temperature		---	+105	°C
Storage Temperature Range		-50	+125	°C
Humidity (non condensing)		---	95	% rel. H
Lead-free Reflow Solder Process	IPC/JEDEC J-STD-020E			

Power Derating Curve

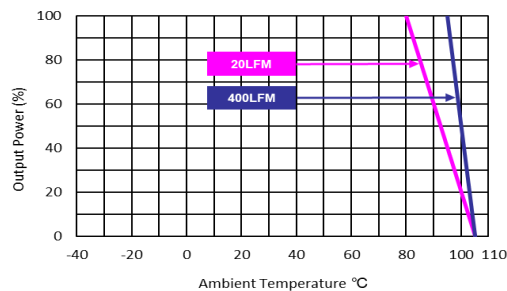

Notes

- Specifications typical at Ta=+25°C, resistive load, nominal input voltage and rated output current unless otherwise noted.
- These power converters require a minimum output loading to maintain specified regulation, operation under no-load conditions will not damage these modules; however they may not meet all specifications listed.
- We recommend to protect the converter by a slow blow fuse in the input supply line.
- Other input and output voltage may be available, please contact MINMAX.
- Specifications are subject to change without notice.
- The repeated high voltage isolation testing of the converter can degrade isolation capability, to a lesser or greater degree depending on materials, construction, environment and and reflow solder process. Any material is susceptible to eventual chemical degradation when subject to very high applied voltages thus implying that the number of tests should be strictly limited. We therefore strongly advise against repeated high voltage isolation testing, but if it is absolutely required, that the voltage be reduced by 20% from specified test voltage. Furthermore, the high voltage isolation capability after reflow solder process should be evaluated as it is applied on system.

Package Specifications

Mechanical Dimensions (5V & 12V Input)

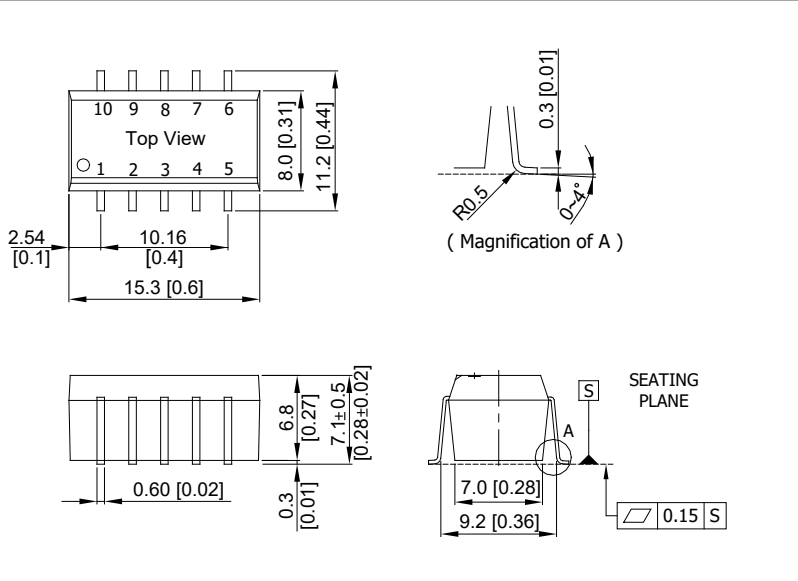

Connecting Pin Patterns

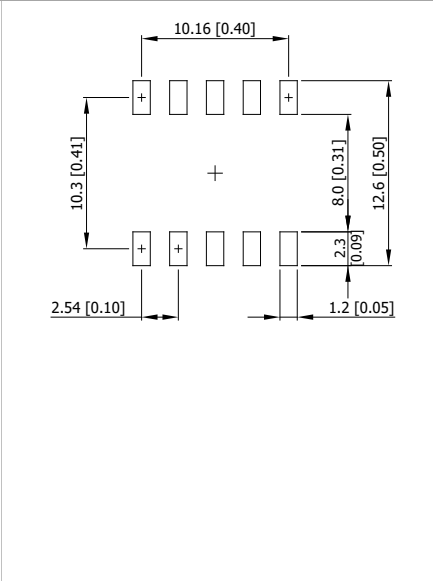

Mechanical Dimensions (24V Input)

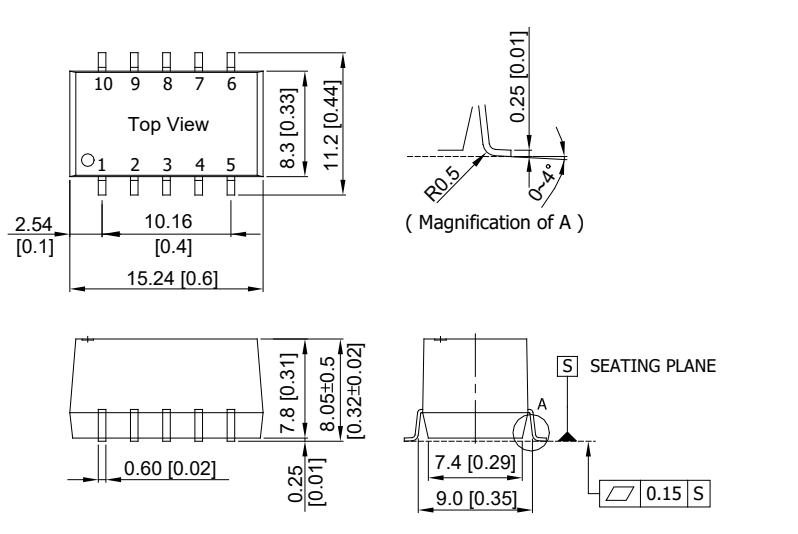

Connecting Pin Patterns

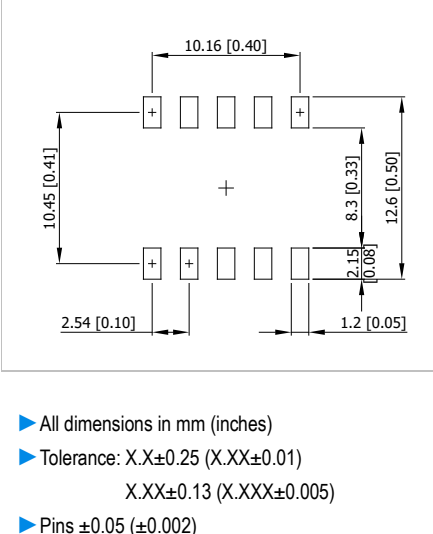

- ▶ All dimensions in mm (inches)
- ▶ Tolerance: X.X±0.25 (X.XX±0.01)
X.XX±0.13 (X.XXX±0.005)
- ▶ Pins ±0.05 (±0.002)

Pin Connections

Pin	Function
1	-Vin
2	+Vin
3	NA
4	Common
5	-Vout
6	NA
7	+Vout
8	NA
9	NA
10	NA

NA : Not Available for Electrical Connection

Physical Characteristics

Case Size (5V&12V Input) : 15.24x8.0x6.8mm (0.60x0.31x0.27 inches)
Case Size (24V Input) : 15.24 x8.3x7.8mm (0.60x0.33x0.31 inches)

Case Material : Molding (flammability to UL 94V-0 rated)

Weight (5V&12V Input) : 1.8g
Weight (24V Input) : 2.2g

Test Setup

Input Reflected-Ripple Current Test Setup

Input reflected-ripple current is measured with an inductor L_{in} (4.7 μ H) and C_{in} (220 μ F, ESR < 1.0 Ω at 100 kHz) to simulate source impedance. Capacitor C_{in} offsets possible battery impedance. Current ripple is measured at the input terminals of the module, measurement bandwidth is 0-500 kHz.

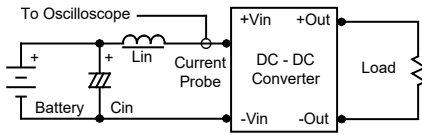

Peak-to-Peak Output Noise Measurement Test

Use a C_{out} 0.33 μ F ceramic capacitor. Scope measurement should be made by using a BNC socket, measurement bandwidth is 0-20 MHz. Position the load between 50 mm and 75 mm from the DC-DC Converter.

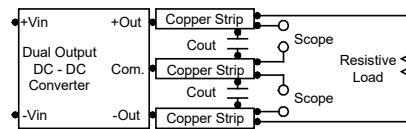

Technical Notes

Maximum Capacitive Load

The MSAU200 series has a limitation on the maximum connected capacitance at the output. The power module may be operated in current limiting mode during start-up, affecting the ramp-up and the startup time. For optimum performance, we recommend a 33 μ F maximum capacitive load. The maximum capacitance can be found in the data sheet.

Input Source Impedance

The power module should be connected to a low ac-impedance input source. Highly inductive source impedances can affect the stability of the power module. In applications where power is supplied over long lines and output loading is high, it may be necessary to use a capacitor at the input to ensure startup. A capacitor mounted close to the power module helps ensure stability of the unit; it is recommended to use a good quality low Equivalent Series Resistance (ESR < 1.0 Ω at 100kHz) capacitor of 2.2 μ F for the 5V input devices, a 1.0 μ F for the 12V input devices, and a 0.47 μ F for the 24V devices.

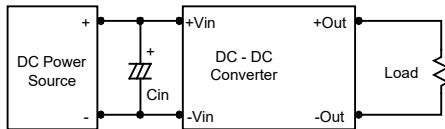

Output Ripple Reduction

A good quality low ESR capacitor placed as close as practicable across the load will give the best ripple and noise performance. To reduce output ripple, it is recommended to use 0.47 μ F capacitors at the output.

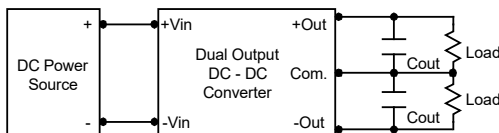

Thermal Considerations

Many conditions affect the thermal performance of the power module, such as orientation, airflow over the module and board spacing. To avoid exceeding the maximum temperature rating of the components inside the power module, the case temperature must be kept below 105°C. The derating curves are determined from measurements obtained in a test setup.

